

ELECTRIC POWERED FORKLIFT
8FB10-J35 1.0 to 3.5 Ton Series

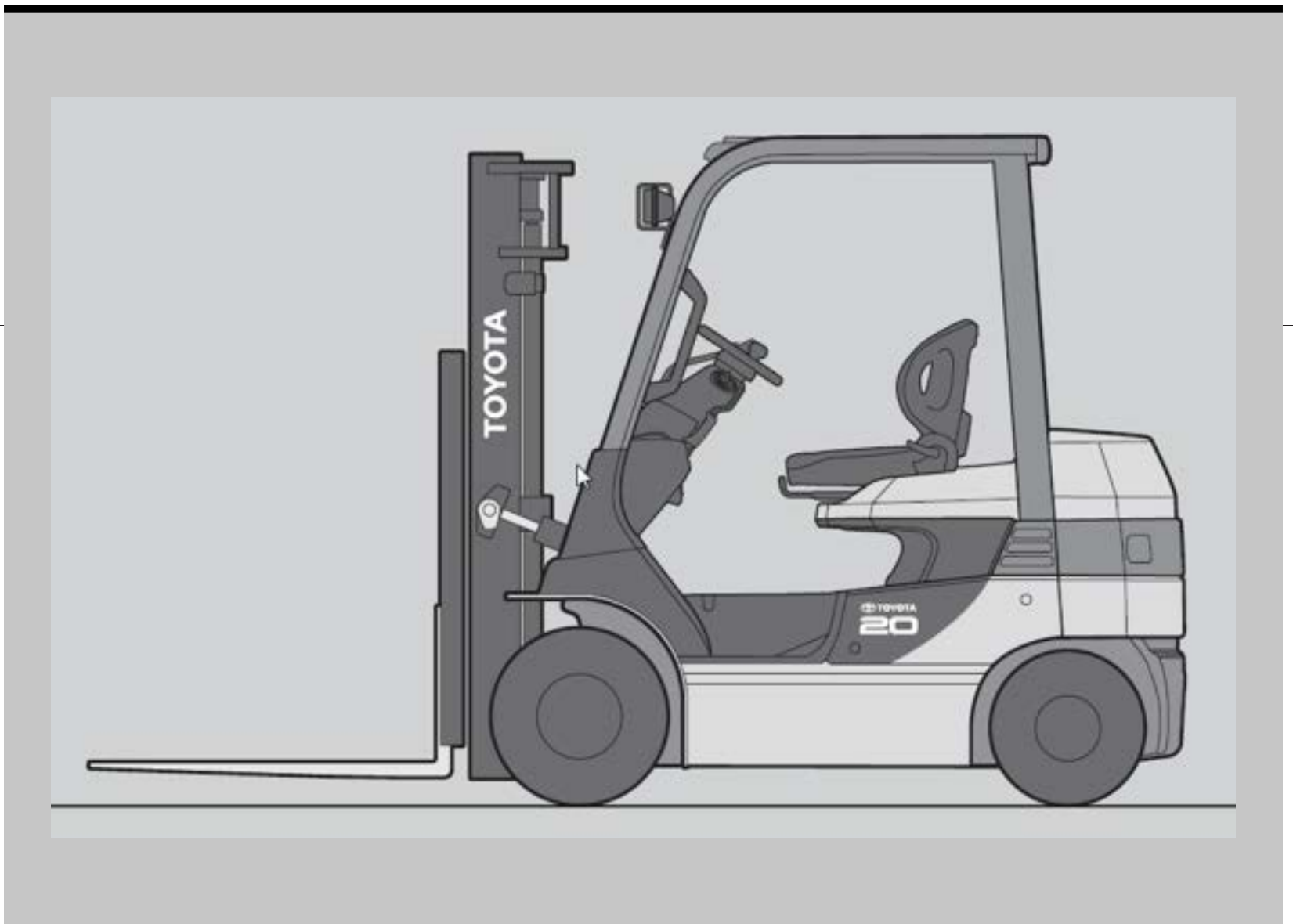

 **TOYOTA**

1,000 kg

MAIN VEHICLE SPECIFICATIONS

1	Manufacturer			TOYOTA	TOYOTA	1	
2	Model			8FB10	8FBH10	2	
3	Load Capacity	kg		1000	1000	3	
4	Load Center	mm		500	500	4	
5	Power Type			Battery	Battery	5	
6	Operator Position			Rider Seated	Rider Seated	6	
7	Tire Type	Front/Rear		Pneumatic	Pneumatic	7	
8	Wheels (x = driven)	Front/Rear		2x/2	2x/2	8	
9	Maximum Fork Height (MFH)	mm		3000	3000	9	
10	Free Lift	mm		140	140	10	
13	Fork Size	L x W x T	mm	1070/100/30	1070/100/30	13	
	Lateral Fork Adjustment	MAX./MIN.	mm	920/200	920/200		
14	Tilt Range	FWD/BWD	deg	7/11	7/11	14	
15	Length to Fork Face		mm	2075	2075	15	
16	Overall Width		mm	1060	1060	16	
17	Mast Lowered Height		mm	1970	1970	17	
18	Mast Extended Height		mm	4220	4220	18	
19	Overhead Guard Height		mm	2025	2105	19	
21	Turning Radius (Outside)		mm	1750	1750	21	
22	Load Distance (Centerline of front axle to front face of forks)		mm	400	400	22	
	Rear Overhang		mm	265	265		
23	Basic Right Angle Stacking Aisle Width (Add load length and clearance)		mm	2150	2150	23	
	Intersecting Aisle Width		mm	1705	1705		
24		Travel, Max. (FWD/RVS)	Full Load	km/h	14.5/14.5	24	
			No Load	km/h	17.0/17.0		
25	Speeds *	Lifting	Full Load	mm/sec	470	25	
			No Load	mm/sec	650		
26		Lowering	Full Load	mm/sec	500	26	
			No Load	mm/sec	550		
27	Drawbar Pull *	Full Load/ No Load	3-Minute Ratings	N (kg)	9260/8650 (940/880)	27	
			5-Minute Ratings	N (kg)	9260/8650(940/880)	9220/8610(940/870)	
			60-Minute Ratings	N (kg)	2750/2750(280/280)	2750/2750(280/280)	
29	Gradeability *	Full Load/ No Load	3-Minute Ratings	% (tanθ)	26/26	29	
			5-Minute Ratings	% (tanθ)	26/26	23/26	
			30-Minute Ratings	% (tanθ)	14/19	14/19	
32	Total Weight	Without Battery	kg	1940	2005	32	
33	Weight Distribution (With STD Battery)	Full Load	Front	kg	2950	33	
			Rear	kg	570	760	
34		No Load	Front	kg	1310	34	
			Rear	kg	1210	1400	
35		Number	Front/Rear		2/2	35	
36	Tires	Size	Front		6.00-9-10-PR (I)	36	
37			Rear		5.00-8-8PR (I)	5.00-8-8PR (I)	
38	Wheelbase		mm	1410	1410	38	
39	Tread		Front	mm	885	39	
			Rear	mm	895	895	
	Backrest Height		mm	1220	1220		
	Overhead Guard Clearance		mm	1035	1035		
	Counterweight Height		mm	1105	1140		
	Drawbar Height		mm	430	430		
	Step Height/Floor Height		mm	430/615	430/695		
40	Underclearance		Mast (Full Load)	mm	75	40	
41			Center of Wheelbase (Full Load)	mm	85	85	41
			Drive Axle (Full Load)	mm	75	75	
			Steer Axle (No Load)	mm	125	125	
			Counterweight (No Load)	mm	120	120	
		Minimum Under Clearance (Full Load)	mm	75(Mast)	75(Mast)		
	Grade Clearance		Frame	% (tanθ)	27		
			Counterweight	% (tanθ)	65	65	
42	Brake		Service (Foot)		Hydraulic	42	
43			Parking		Hand	Hand	43
45	Battery	Voltage/Capacity (5-hour rating)	STD	V/AH	48/330	45	
			High	V/AH	48/485	-	
46		Weight (STD Capacity Type)	kg	580	845	46	
47	Electric Motors		Drive	kW	7.6	47	
48			Load Handling	kW	9.5	9.5	48
			Energy Consumption According to VDI Cycle **	kWh/h	3.6	3.6	
54	Control Type		Drive		Trasistor inverter	54	
			Load Handling		Trasistor inverter	Trasistor inverter	
57	Operating Pressure	For Attachments	Mpa (psi)	11.8 (1700)	11.8 (1700)	57	
		Sound level at the driver's ear according to EN12053 Uncertainty 4dB(A)	dB(A)	-	-		
		Vibration in accordance with in EN13059	m/s2	-	-		

NOTE: * Computed values.

** 60 VDI Work Cycles/h with Tested Load of 1000 kg.

8FB10/8FBH10

DIMENSIONAL DRAWINGS

Unit: mm
[] for 8FBH10

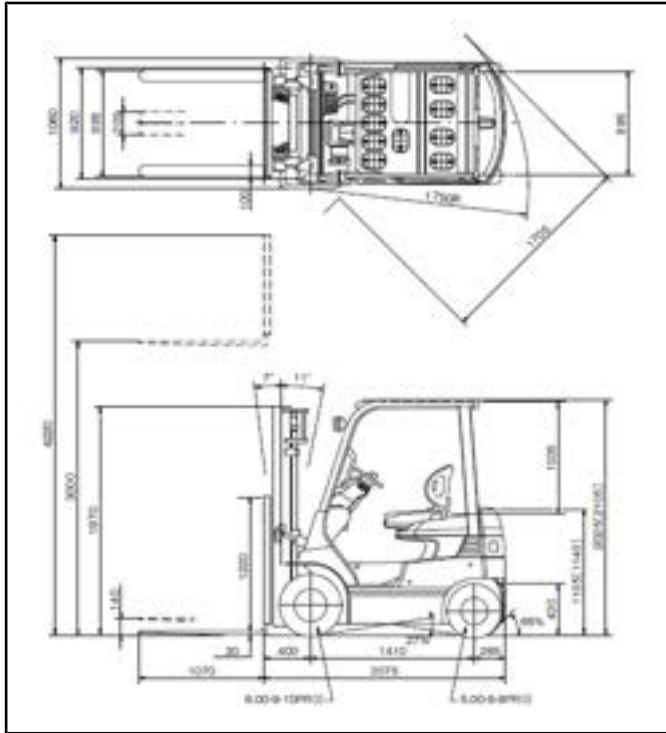

UNDERCLEARANCE

Unit: mm

Mast (Full Load)	75
Center of Wheelbase (Full Load)	85
Drive Axle (Full Load)	75
Steer Axle (No Load)	125
Counterweight (No Load)	120
Minimum Under Clearance (Full Load)	75(Mast)

RATED CAPACITIES

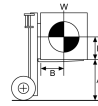

A: Max. Fork Height
B: Load Center
W: Capacity

V, FV Mast

Unit: kg (W)

A (mm)		3000	3300	3500	3700	4000	4500	5000
Single	500	1000	1000	1000	1000	1000	1000	950
	600	900	900	900	900	900	900	850
	700	810	810	810	810	810	810	770
	800	750	750	750	750	750	750	710
	900	690	690	690	690	690	690	650
	1000	640	640	640	640	640	640	610
	1100	600	600	600	600	600	600	570
Dual	1200	560	560	560	560	560	560	530
	500	1000	1000	1000	1000	1000	1000	1000
	600	900	900	900	900	900	900	900
	700	810	810	810	810	810	810	810
	800	750	750	750	750	750	750	750
	900	690	690	690	690	690	690	690
	1000	640	640	640	640	640	640	640
1100	600	600	600	600	600	600	600	
1200	560	560	560	560	560	560	560	

FSV Mast

Unit: kg (W)

A (mm)		3700	4000	4300	4500	4700	5000	5500	6000
Single	500	950	900	900	900	900	850	750	600
	600	850	810	810	810	810	760	670	540
	700	780	730	730	730	730	690	610	490
	800	710	670	670	670	670	640	560	450
	900	660	620	620	620	620	590	520	410
	1000	610	580	580	580	580	550	480	380
	1100	570	540	540	540	540	510	450	360
	1200	530	510	510	510	510	480	420	340
	Dual	500	950	900	900	900	900	850	850
600		850	810	810	810	810	760	760	720
700		780	730	730	730	730	690	690	650
800		710	670	670	670	670	640	640	600
900		660	620	620	620	620	590	590	500
1000		610	580	580	580	580	550	550	510
1100		570	540	540	540	540	510	510	480
1200		530	510	510	510	510	480	480	450

MAST SPECIFICATIONS & RATED CAPACITIES

Mast Type	Maximum Fork Height	Overall Height			Free Lift		Tilt Range		Load Capacity at 500 mm LC	
		Lowered	Extended		Without Load Backrest	With Standard Load Backrest	FWD	BWD	PN	PSC
			Without Load Backrest	With Standard Load Backrest						
mm	mm	mm	mm	mm	mm	deg	deg	kg	kg	
Wide Visible Mast (V)	2500	1720	3110	3420	140	140	7	11	1000	1000
	2700	1820	3310	3620	140	140	7	11	1000	1000
	3000	1970	3610	3920	140	140	7	11	1000	1000
	3300	2120	3910	4220	140	140	7	11	1000	1000
	3500	2220	4110	4420	140	140	7	11	1000	1000
	3700	2380	4310	4620	140	140	7	11	1000	1000
	4000	2570	4610	4920	140	140	7	11	1000	1000
	4500	2820	5110	5420	140	140	7	5	1000	1000
	5000	3070	5610	5920	140	140	7	5	950	1000
Wide Visible Full-Free Lift Two-Stage Mast (FV)	3000	1970	3570	3920	1400*	1050*	7	11	1000	1000
	3300	2120	3870	4220	1550*	1200*	7	11	1000	1000
	3500	2220	4070	4420	1650*	1300*	7	11	1000	1000
	3700	2380	4270	4620	1810*	1460*	7	11	1000	1000
	4000	2570	4570	4920	2000*	1650*	7	11	1000	1000
Wide Visible Full-Free Lift Three-Stage Mast (FSV)	3700	1770	4245	4620	1230*	850*	7	5	950	950
	4000	1870	4545	4920	1330*	950*	7	5	900	900
	4300	1970	4845	5220	1430*	1050*	7	5	900	900
	4500	2040	5045	5420	1500*	1120*	7	5	900	900
	4700	2120	5245	5620	1580*	1200*	7	5	900	900
	5000	2220	5545	5920	1680*	1300*	7	5	850	850
	5500	2380	6045	6420	1840*	1460*	7	5	750	850
6000	2570	6545	6920	2030*	1650*	7	5	600	800	

NOTE: Height of standard load backrest is 920 mm.
* with optional tire sized 6.50-10-12PR, free lift is 25mm longer.

1,350 kg

MAIN VEHICLE SPECIFICATIONS

1	Manufacturer			TOYOTA	TOYOTA	1
2	Model			8FB14	8FBH14	2
3	Load Capacity		kg	1350	1350	3
4	Load Center		mm	500	500	4
5	Power Type			Battery	Battery	5
6	Operator Position			Rider Seated	Rider Seated	6
7	Tire Type		Front/Rear	Pneumatic	Pneumatic	7
8	Wheels (x = driven)		Front/Rear	2x/2	2x/2	8
9	Maximum Fork Height (MFH)		mm	3000	3000	9
10	Free Lift		mm	145	145	10
13	Fork Size		L x W x T	1070/100/35	1070/100/35	13
	Lateral Fork Adjustment		MAX./MIN.	920/200	920/200	
14	Tilt Range		FWD/BWD	7/11	7/11	14
15	Length to Fork Face		mm	2080	2080	15
16	Overall Width		mm	1060	1060	16
17	Mast Lowered Height		mm	1970	1970	17
18	Mast Extended Height		mm	4220	4220	18
19	Overhead Guard Height		mm	2025	2105	19
21	Turning Radius (Outside)		mm	1760	1760	21
22	Load Distance (Centerline of front axle to front face of forks)		mm	405	405	22
	Rear Overhang		mm	265	265	
23	Basic Right Angle Stacking Aisle Width (Add load length and clearance)		mm	2165	2165	23
	Intersecting Aisle Width		mm	1725	1725	
24	Speeds *	Travel, Max. (FWD/RVS)	Full Load	km/h	14.5/14.5	24
			No Load	km/h	17.0/17.0	
		Lifting	Full Load	mm/sec	430	25
			No Load	mm/sec	650	
26	Lowering	Full Load	mm/sec	500	26	
		No Load	mm/sec	550		
27	Drawbar Pull *	Full Load/ No Load	3-Minute Ratings	N (kg)	9200/8640(930/880)	27
			5-Minute Ratings	N (kg)	9200/8640 (930/880)	
			60-Minute Ratings	N (kg)	2750/2750 (280/280)	2750/2750 (280/280)
29	Gradeability *	Full Load/ No Load	3-Minute Ratings	% (tanθ)	22/26	29
			5-Minute Ratings	% (tanθ)	22/26	
			30-Minute Ratings	% (tanθ)	13/19	13/19
32	Total Weight	Without Battery	kg	2030	2075	32
33	Weight Distribution (With STD Battery)	Full Load	Front	kg	3550	33
			Rear	kg	410	590
34	No Load	Front	kg	1330	1460	34
		Rear	kg	1280	1460	
35	Tires	Number	Front/Rear	2/2	2/2	35
36	Size	Front		6.00-9-10-PR (I)	6.00-9-10-PR (I)	36
37		Rear		5.00-8-8PR (I)	5.00-8-8PR (I)	37
38	Wheelbase		mm	1410	1410	38
39	Tread	Front	mm	885	885	39
		Rear	mm	895	895	
	Backrest Height		mm	1220	1220	
	Overhead Guard Clearance		mm	1035	1035	
	Counterweight Height		mm	1105	1140	
	Drawbar Height		mm	430	430	
	Step Height/Floor Height		mm	430/615	430/695	
40	Underclearance	Mast (Full Load)	mm	70	65	40
41		Center of Wheelbase (Full Load)	mm	85	85	41
		Drive Axle (Full Load)	mm	70	65	
		Steer Axle (No Load)	mm	125	125	
		Counterweight (No Load)	mm	120	120	
		Minimum Under Clearance (Full Load)	mm	70(Mast)	65(Mast)	
	Grade Clearance	Frame	% (tanθ)	27	27	
		Counterweight	% (tanθ)	65	65	
42	Brake	Service (Foot)		Hydraulic	Hydraulic	42
43		Parking		Hand	Hand	43
45	Battery	Voltage/Capacity (5-hour rating)	V/AH	48/330	48/545	45
		High	V/AH	48/485	-	
46	Weight (STD Capacity Type)		kg	580	845	46
47	Electric Motors	Drive	kW	7.6	7.6	47
48		Load Handling	kW	9.5	9.5	48
		Energy Consumption According to VDI Cycle **	kWh/h	3.8	3.8	
54	Control Type	Drive		Trasistor inverter	Trasistor inverter	54
		Load Handling		Trasistor inverter	Trasistor inverter	
57	Operating Pressure	For Attachments	Mpa (psi)	11.8 (1700)	11.8 (1700)	57
	Sound level at the driver's ear according to EN12053 Uncertainty 4dB(A)		dB(A)	-	-	
	Vibration in accordance with in EN13059		m/s2	-	-	

NOTE: * Computed values.

** 60 VDI circles/h with Tested Load of 1350 kg.

8FB14/8FBH14

DIMENSIONAL DRAWINGS

Unit: mm
[] for 8FBH14

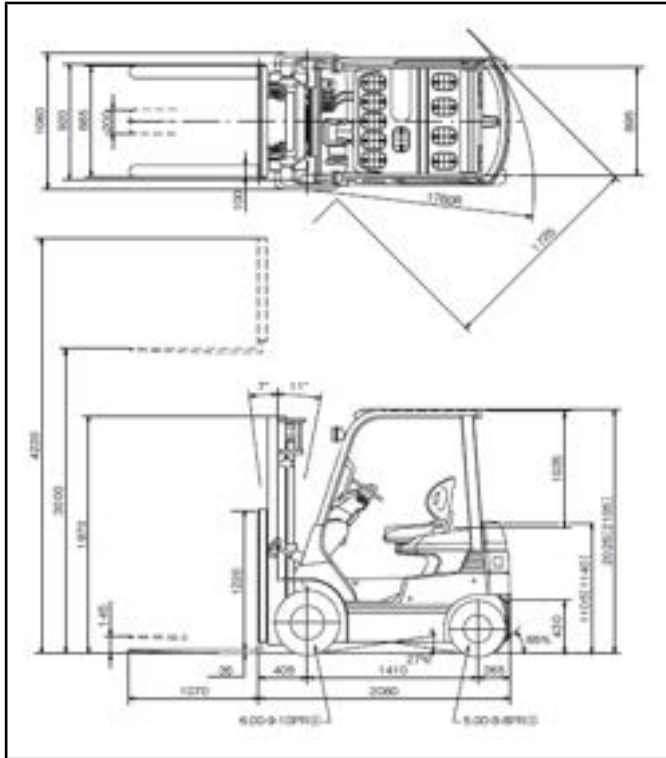

UNDERCLEARANCE

Unit: mm

Mast (Full Load)	70 [65]
Center of Wheelbase (Full Load)	85
Drive Axle (Full Load)	70 [65]
Steer Axle (No Load)	125
Counterweight (No Load)	120
Minimum Under Clearance (Full Load)	70 [65] (Mast)

RATED CAPACITIES

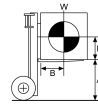

A: Max. Fork Height
B: Load Center
W: Capacity

V, FV Mast

Unit: kg (W)

A (mm)		3000	3300	3500	3700	4000	4500	5000
Single	500	1350	1350	1350	1350	1350	1250	1150
	600	1210	1210	1210	1210	1100	1120	1030
	700	1100	1100	1100	1100	1100	1020	940
	800	1010	1010	1010	1010	1010	930	860
	900	930	930	930	930	930	860	790
	1000	860	860	860	860	860	800	740
	1100	810	810	810	810	810	750	690
Dual	1200	760	760	760	760	760	700	640
	500	1350	1350	1350	1350	1350	1250	1200
	600	1210	1210	1210	1210	1210	1120	1080
	700	1100	1100	1100	1100	1100	1020	980
	800	1010	1010	1010	1010	1010	930	900
	900	930	930	930	930	930	860	830
	1000	860	860	860	860	860	800	770
1100	810	810	810	810	810	750	720	
1200	760	760	760	760	760	700	670	

FSV Mast

Unit: kg (W)

A (mm)		3700	4000	4300	4500	4700	5000	5500	6000
Single	500	1250	1200	1200	1150	1150	1000	800	650
	600	1120	1080	1080	1030	1030	900	720	580
	700	1020	980	980	940	940	820	650	530
	800	940	900	900	860	860	750	600	490
	900	870	830	830	800	800	690	550	450
	1000	810	770	770	740	740	640	510	420
	1100	750	720	720	690	690	600	480	390
Dual	1200	710	680	680	650	650	560	450	360
	500	1250	1200	1200	1150	1150	1100	1100	1050
	600	1120	1080	1080	1030	1030	990	990	940
	700	1020	980	980	940	940	900	900	860
	800	940	900	900	860	860	830	830	790
	900	870	830	830	800	800	760	760	730
	1000	810	770	770	740	740	710	710	680
1100	750	720	720	690	690	660	660	630	
1200	710	680	680	650	650	620	620	590	

MAST SPECIFICATIONS & RATED CAPACITIES

Mast Type	Maximum Fork Height	Overall Height			Free Lift		Tilt Range		Load Capacity at 500 mm LC	
		Lowered	Extended		Without Load Backrest	With Standard Load Backrest	FWD	BWD	PN	PSC
			Without Load Backrest	With Standard Load Backrest						
mm		mm	mm	mm	mm	mm	deg	deg	kg	kg
Wide Visible Mast (V)	2500	1720	3105	3420	145	145	7	11	1350	1350
	2700	1820	3305	3620	145	145	7	11	1350	1350
	3000	1970	3605	3920	145	145	7	11	1350	1350
	3300	2120	3905	4220	145	145	7	11	1350	1350
	3500	2220	4105	4420	145	145	7	11	1350	1350
	3700	2380	4305	4620	145	145	7	11	1350	1350
	4000	2570	4605	4920	145	145	7	11	1350	1350
	4500	2820	5105	5420	145	145	7	5	1250	1250
Wide Visible Full-Free Lift Two-Stage Mast (FV)	3000	1970	3565	3920	1405*	1050*	7	11	1350	1350
	3300	2120	3865	4220	1555*	1200*	7	11	1350	1350
	3500	2220	4065	4420	1655*	1300*	7	11	1350	1350
	3700	2380	4265	4620	1815*	1460*	7	11	1350	1350
Wide Visible Full-Free Lift Three-Stage Mast (FSV)	4000	2570	4565	4920	2005*	1650*	7	11	1350	1350
	3700	1770	4240	4620	1235*	850*	7	5	1250	1250
	4000	1870	4540	4920	1335*	950*	7	5	1200	1200
	4300	1970	4840	5220	1435*	1050*	7	5	1200	1200
	4500	2040	5040	5420	1505*	1120*	7	5	1150	1150
	4700	2120	5240	5620	1585*	1200*	7	5	1150	1150
	5000	2220	5540	5920	1685*	1300*	7	5	1000	1100
	5500	2380	6040	6420	1845*	1460*	7	5	800	1100
6000	2570	6540	6920	2035*	1650*	7	5	650	1050	

NOTE: Height of standard load backrest is 920 mm.
* with optional tire sized 6.50-10-12PR, free lift is 25mm longer.

1,500 kg

MAIN VEHICLE SPECIFICATIONS

1	Manufacturer			TOYOTA	TOYOTA	1
2	Model			8FB15	8FBH15	2
3	Load Capacity		kg	1500	1500	3
4	Load Center		mm	500	500	4
5	Power Type			Battery	Battery	5
6	Operator Position			Rider Seated	Rider Seated	6
7	Tire Type		Front/Rear	Pneumatic	Pneumatic	7
8	Wheels (x = driven)		Front/Rear	2x/2	2x/2	8
9	Maximum Fork Height (MFH)		mm	3000	3000	9
10	Free Lift		mm	145	145	10
13	Fork Size		L x W x T	1070/100/35	1070/100/35	13
	Lateral Fork Adjustment		MAX./MIN.	920/200	920/200	
14	Tilt Range		FWD/BWD	7/11	7/11	14
15	Length to Fork Face		mm	2080	2080	15
16	Overall Width		mm	1115	1115	16
17	Mast Lowered Height		mm	1970	1970	17
18	Mast Extended Height		mm	4220	4220	18
19	Overhead Guard Height		mm	2025	2105	19
21	Turning Radius (Outside)		mm	1770	1770	21
22	Load Distance (Centerline of front axle to front face of forks)		mm	405	405	22
	Rear Overhang		mm	265	265	
23	Basic Right Angle Stacking Aisle Width (Add load length and clearance)		mm	2175	2175	23
	Intersecting Aisle Width		mm	1760	1760	
24		Travel, Max. (FWD/RVS)	Full Load	km/h	14.5/14.5	24
			No Load	km/h	17.0/17.0	
25	Speeds *	Lifting	Full Load	mm/sec	420	25
			No Load	mm/sec	650	
26		Lowering	Full Load	mm/sec	500	26
			No Load	mm/sec	550	
27	Drawbar Pull *	Full Load/ No Load	3-Minute Ratings	N (kg)	9150/8620 (930/870)	27
			5-Minute Ratings	N (kg)	9150/8620 (930/870)	
			60-Minute Ratings	N (kg)	2750/2750 (280/280)	2750/2750 (280/280)
29	Gradeability *	Full Load/ No Load	3-Minute Ratings	% (tanθ)	20/25	29
			5-Minute Ratings	% (tanθ)	20/25	
			30-Minute Ratings	% (tanθ)	12/19	12/19
32	Total Weight	Without Battery	kg	2060	2155	32
33	Weight Distribution (With STD Battery)	Full Load	Front	kg	3790	33
			Rear	kg	450	580
34		No Load	Front	kg	1330	34
			Rear	kg	1410	1540
35		Number	Front/Rear		2/2	35
36	Tires	Size	Front		6.00-9-10-PR (I)	36
37			Rear		5.00-8-8PR (I)	5.00-8-8PR (I)
38	Wheelbase		mm	1410	1410	38
39	Tread		Front	mm	960	39
			Rear	mm	895	895
	Backrest Height		mm	1220	1220	
	Overhead Guard Clearance		mm	1035	1035	
	Counterweight Height		mm	1105	1140	
	Drawbar Height		mm	430	430	
	Step Height/Floor Height		mm	430/615	430/695	
40	Underclearance	Mast (Full Load)		mm	65	40
41		Center of Wheelbase (Full Load)		mm	85	41
		Drive Axle (Full Load)		mm	65	
		Steer Axle (No Load)		mm	125	
		Counterweight (No Load)		mm	120	
		Minimum Under Clearance (Full Load)		mm	65(Mast)	65(Mast)
	Grade Clearance	Frame		% (tanθ)	27	
		Counterweight		% (tanθ)	65	65
42	Brake	Service (Foot)			Hydraulic	42
43		Parking			Hand	43
45	Battery	Voltage/Capacity (5-hour rating)	STD	V/AH	48/400	45
			High	V/AH	48/485	-
46	Weight (STD Capacity Type)		kg	680	845	46
47	Electric Motors	Drive		kW	7.6	47
48		Load Handling		kW	9.5	48
		Energy Consumption According to VDI Cycle **		kWh/h	3.9	4.0
54	Control Type	Drive			Trasistor inverter	54
		Load Handling			Trasistor inverter	Trasistor inverter
57	Operating Pressure	For Attachments	Mpa (psi)	11.8 (1700)	11.8 (1700)	57
	Sound level at the driver's ear according to EN12053 Uncertainty 4dB(A)		dB(A)	68	68	
	Vibration in accordance with in EN13059		m/s2	1.5	1.5	

NOTE: * Computed values.

** 60 VDI circles/h with Tested Load of 1500 kg.

8FB15/8FBH15

DIMENSIONAL DRAWINGS

Unit: mm
[] for 8FBH15

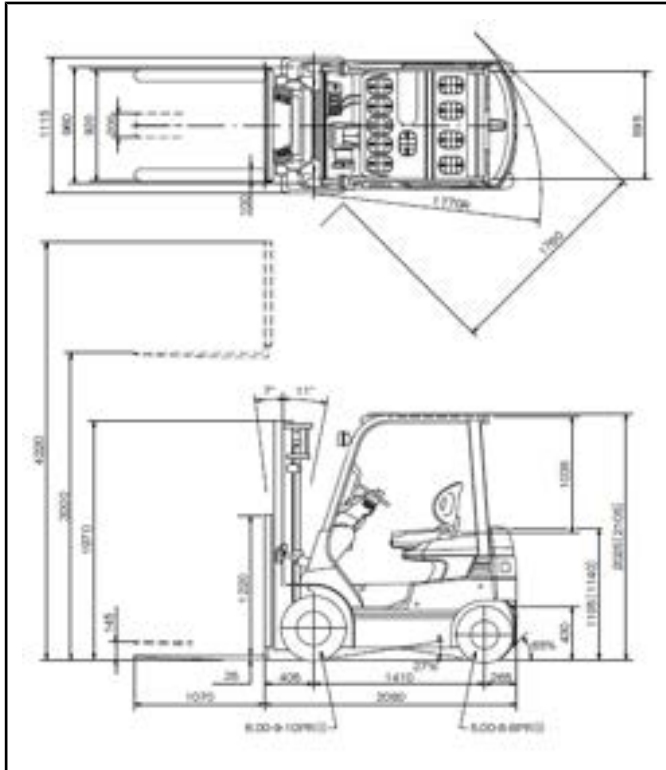

UNDERCLEARANCE

Unit: mm

Mast (Full Load)	65
Center of Wheelbase (Full Load)	85
Drive Axle (Full Load)	65
Steer Axle (No Load)	125
Counterweight (No Load)	120
Minimum Under Clearance (Full Load)	65(Mast)

RATED CAPACITIES

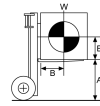

A: Max. Fork Height
B: Load Center
W: Capacity

V, FV Mast

Unit: kg (W)

A (mm)		3000	3300	3500	3700	4000	4500	5000
Single	500	1500	1500	1500	1500	1500	1450	1350
	600	1350	1350	1350	1350	1350	1300	1210
	700	1220	1220	1220	1220	1220	1180	1100
	800	1120	1120	1120	1120	1120	1080	1010
	900	1040	1040	1040	1040	1040	1000	930
	1000	960	960	960	960	960	930	860
	1100	900	900	900	900	900	870	810
Dual	1200	840	840	840	840	840	810	760
	500	1500	1500	1500	1500	1500	1450	1400
	600	1350	1350	1350	1350	1350	1300	1260
	700	1220	1220	1220	1220	1220	1180	1140
	800	1120	1120	1120	1120	1120	1080	1050
	900	1040	1040	1040	1040	1040	1040	970
	1000	960	960	960	960	960	960	900
1100	900	900	900	900	900	870	840	
1200	840	840	840	840	840	840	810	780

FSV Mast

Unit: kg (W)

A (mm)		3700	4000	4300	4500	4700	5000	5500	6000
Single	500	1400	1400	1400	1350	1350	1200	1100	900
	600	1260	1260	1260	1210	1210	1080	990	810
	700	1150	1150	1150	1100	1100	980	900	730
	800	1050	1050	1050	1010	1010	900	830	670
	900	970	970	970	940	940	830	760	620
	1000	900	900	900	870	870	770	710	580
	1100	840	840	840	810	810	720	660	540
Dual	1200	790	790	790	760	760	680	620	510
	500	1400	1400	1400	1350	1350	1300	1250	1100
	600	1260	1260	1260	1210	1210	1170	1120	990
	700	1150	1150	1150	1100	1100	980	930	570
	800	1120	1050	1050	1010	1010	1060	1020	900
	900	970	970	970	940	940	900	870	760
	1000	900	900	900	870	870	840	810	710
1100	840	840	840	810	810	780	750	660	
1200	790	790	790	760	760	730	710	620	

MAST SPECIFICATIONS & RATED CAPACITIES

Mast Type	Maximum Fork Height	Overall Height				Free Lift		Tilt Range		Load Capacity at 500 mm LC	
		Lowered	Extended		Without Load Backrest	With Standard Load Backrest	FWD	BWD	PN	PSC	
			Without Load Backrest	With Standard Load Backrest							deg
mm	mm	mm	mm	mm	mm	mm	deg	deg	kg	kg	
Wide Visible Mast (V)	2500	1720	3105	3420	145	145	7	11	1500	1500	
	2700	1820	3305	3620	145	145	7	11	1500	1500	
	3000	1970	3605	3920	145	145	7	11	1500	1500	
	3300	2120	3905	4220	145	145	7	11	1500	1500	
	3500	2220	4105	4420	145	145	7	11	1500	1500	
	3700	2380	4305	4620	145	145	7	11	1500	1500	
	4000	2570	4605	4920	145	145	7	5	1500	1500	
	4500	2820	5105	5420	145	145	7	5	1450	1450	
Wide Visible Full-Free Lift Two-Stage Mast (FV)	5000	3070	5605	5920	145	145	7	11	1350	1400	
	3000	1970	3565	3920	1405*	1050*	7	11	1500	1500	
	3300	2120	3865	4220	1555*	1200*	7	11	1500	1500	
	3500	2220	4065	4420	1655*	1300*	7	11	1500	1500	
Wide Visible Full-Free Lift Three-Stage Mast (FSV)	3700	2380	4265	4620	1815*	1460*	7	11	1500	1500	
	4000	2570	4565	4920	2005*	1650*	7	5	1500	1500	
	3700	1770	4240	4620	1235*	850*	7	5	1400	1400	
	4000	1870	4540	4920	1335*	950*	7	5	1400	1400	
	4300	1970	4840	5220	1435*	1050*	7	5	1400	1400	
	4500	2040	5040	5420	1505*	1120*	7	5	1350	1350	
4700	2120	5240	5620	1585*	1200*	7	5	1350	1350		
5000	2220	5540	5920	1685*	1300*	7	5	1200	1300		
5500	2380	6040	6420	1845*	1460*	7	5	1100	1250		
6000	2570	6540	6920	2035*	1650*	7	5	900	1100		

NOTE: Height of standard load backrest is 920 mm.
* with optional tire sized 6.50-10-12PR, free lift is 25mm longer.

1,500 kg

MAIN VEHICLE SPECIFICATIONS

1	Manufacturer			TOYOTA	1	
2	Model			40-8FB15	2	
3	Load Capacity		kg	1500	3	
4	Load Center		mm	500	4	
5	Power Type			Battery	5	
6	Operator Position			Rider Seated	6	
7	Tire Type		Front/Rear	Pneumatic	7	
8	Wheels (x = driven)		Front/Rear	2x/2	8	
9	Maximum Fork Height (MFH)		mm	3000	9	
10	Free Lift		mm	125	10	
13	Fork Size		L x W x T	1070/100/35	13	
	Fork Spread (Outside)		MAX./MIN.	920/200		
14	Tilt Range		FWD/BWD	7/11	14	
15	Length to Fork Face		mm	2215	15	
16	Overall Width		mm	1160	16	
17	Mast Lowered Height		mm	1975	17	
18	Mast Extended Height		mm	4220	18	
19	Overhead Guard Height		mm	2105	19	
21	Turning Radius (Outside)		mm	1980	21	
22	Load Distance (Centerline of front axle to front face of forks)		mm	415	22	
	Rear Overhang		mm	300		
23	Basic Right Angle Stacking Aisle Width (Add load length and clearance)		mm	2395	23	
	Intersecting Aisle Width		mm	1825		
24	Speeds *	Travel, Max. (FWD/RVS)	Full Load	km/h	14.0/14.0	24
			No Load	km/h	16.0/16.0	
		Lowering	Full Load	mm/sec	380	25
			No Load	mm/sec	600	
26			Full Load	mm/sec	500	26
			No Load	mm/sec	500	
27	Drawbar Pull *	Full Load/ No Load	3-Minute Ratings	N (kg)	11330/10640 (1150/1080)	27
			5-Minute Ratings	N (kg)	11330/10640 (1150/1080)	
			60-Minute Ratings	N (kg)	4710/4900 (480/500)	
29	Gradeability *	Full Load/ No Load	3-Minute Ratings	% (tanθ)	24/25	29
			5-Minute Ratings	% (tanθ)	24/25	
			30-Minute Ratings	% (tanθ)	17/25	
32	Total Weight	Without Battery	kg	2465	32	
33	Weight Distribution (With STD Battery)	Full Load	Front	kg	4060	33
			Rear	kg	860	
34		No Load	Front	kg	1650	34
			Rear	kg	1770	
35		Number	Front/Rear		2/2	35
36	Tires	Size	Front		21X8-9-14PR (I)	36
37			Rear			18X7-8-14PR (I)
38	Wheelbase		mm	1500	38	
39	Tread	Front	mm	970	39	
		Rear	mm	940		
	Backrest Height			1220		
	Overhead Guard Clearance			1035		
	Counterweight Height			1135		
	Drawbar Height			280		
	Step Height/Floor Height			435/700		
40	Underclearance	Mast (Full Load)		mm	75	40
41		Center of Wheelbase (Full Load)		mm	90	41
		Drive Axle (Full Load)		mm	75	
		Steer Axle (No Load)		mm	120	
		Counterweight (No Load)		mm	115	
		Minimum Under Clearance (Full Load)		mm	75(Mast)	
	Grade Clearance	Frame	% (tanθ)	25		
		Counterweight	% (tanθ)	63		
42	Brake	Service (Foot)			Hydraulic	42
43		Parking			Hand	43
45	Battery	Voltage/Capacity (5-hour rating)	STD	V/AH	48/600	45
			High	V/AH	48/730	
46	Weight (STD Capacity Type)		kg	955	46	
47	Electric Motors	Drive		kW	10.7	47
48		Load Handling		kW	12.2	48
		Energy Consumption According to VDI Cycle **		kWh/h	4.3	
54	Control Type	Drive			Transistor inverter	54
		Load Handling			Transistor inverter	
57	Operating Pressure		For Attachments	Mpa (psi)	14.7 (2100)	57
	Sound level at the driver's ear according to EN12053 Uncertainty 4dB(A)			dB (A)	-	
	Vibration in accordance with in EN13059			m/s2	-	

NOTE: * Computed values.

** 60 VDI circles/h with Tested Load of 1500 kg.

DIMENSIONAL DRAWINGS

Unit: mm

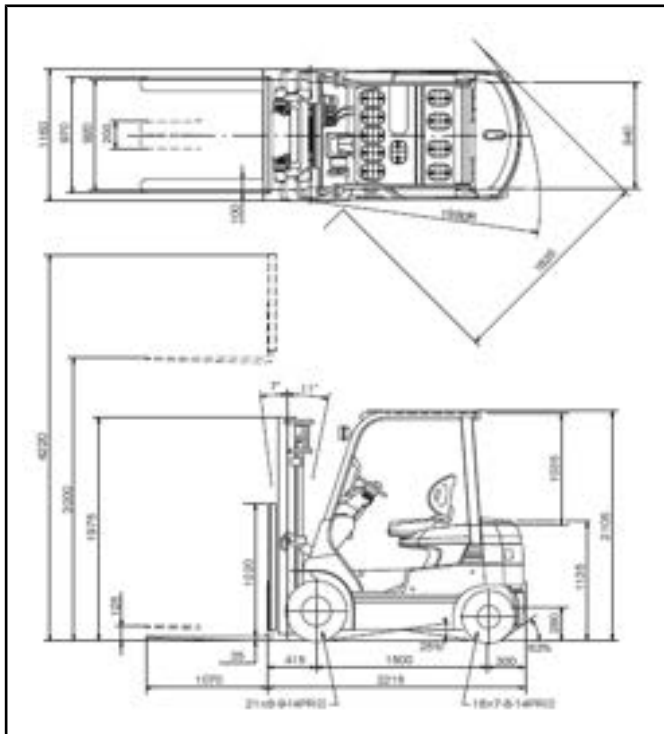

UNDERCLEARANCE

Unit: mm

Mast (Full Load)	75
Center of Wheelbase (Full Load)	90
Drive Axle (Full Load)	75
Counterweight (No Load)	120
Steer Axle (No Load)	115
Minimum Under Clearance (No Load)	75 (Frame)

RATED CAPACITIES

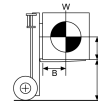

A: Max. Fork Height
B: Load Center
W: Capacity

V, FV Mast

Unit: kg (W)

A (mm)		3000	3300	3500	3700	4000	4500	5000
Single	500	1500	1500	1500	1500	1500	1450	1350
	600	1350	1350	1350	1350	1350	1300	1210
	700	1230	1230	1230	1230	1230	1190	1100
	800	1120	1120	1120	1120	1120	1090	1010
	900	1040	1040	1040	1040	1040	1000	930
	1000	970	970	970	970	970	930	870
Dual	1100	900	900	900	900	900	870	810
	1200	850	850	850	850	850	820	760
	500	1500	1500	1500	1500	1500	1450	1400
	600	1350	1350	1350	1350	1350	1300	1260
	700	1230	1230	1230	1230	1230	1190	1140
	800	1120	1120	1120	1120	1120	1090	1050
Dual	900	1040	1040	1040	1040	1040	1000	975
	1000	970	970	970	970	970	930	900
	1100	900	900	900	900	900	870	840
	1200	850	850	850	850	850	820	790

FSV Mast

Unit: kg (W)

A (mm)		3700	4000	4300	4500	4700	5000	5500	6000
Single	500	1400	1400	1400	1350	1350	1200	1100	900
	600	1260	1260	1260	1220	1220	1080	990	810
	700	1150	1150	1150	1110	1110	990	900	740
	800	1060	1060	1060	1020	1020	910	830	680
	900	980	980	980	940	940	840	770	630
	1000	910	910	910	880	880	780	710	580
Dual	1100	850	850	850	820	820	730	670	550
	1200	800	800	800	770	770	680	630	510
	500	1400	1400	1400	1350	1350	1300	1250	1100
	600	1260	1260	1260	1220	1220	1170	1130	990
	700	1150	1150	1150	1110	1110	1070	1030	900
	800	1060	1060	1060	1020	1020	980	940	830
Dual	900	980	980	980	940	940	910	870	770
	1000	910	910	910	880	880	840	810	710
	1100	850	850	850	820	820	790	760	670
	1200	800	800	800	770	770	740	710	630

MAST SPECIFICATIONS & RATED CAPACITIES

Mast Type	Maximum Fork Height	Overall Height			Free Lift		Tilt Range		Load Capacity at 500 mm LC	
		Lowered	Extended		Without Load Backrest	With Standard Load Backrest	FWD	BWD	PN	PSC
			Without Load Backrest	With Standard Load Backrest						
mm	mm	mm	mm	mm	mm	deg	deg	kg	kg	
Wide Visible Mast (V)	2500	1725	3170	3420	125	125	7	11	1500	1500
	2700	1825	3370	3620	125	125	7	11	1500	1500
	3000	1975	3670	3920	125	125	7	11	1500	1500
	3300	2125	3970	4220	125	125	7	11	1500	1500
	3500	2225	4170	4420	125	125	7	11	1500	1500
	3700	2385	4370	4620	125	125	7	11	1500	1500
	4000	2575	4670	4920	125	125	7	11	1500	1500
	4500	2825	5170	5420	125	125	7	5	1450	1450
Wide Visible Full-Free Lift Two-Stage Mast (FV)	5000	3075	5670	5920	125	125	7	5	1350	1400
	3000	1975	3605	3920	1370*	1055*	7	11	1500	1500
	3300	2125	3905	4220	1520*	1205*	7	11	1500	1500
	3500	2225	4105	4420	1620*	1305*	7	11	1500	1500
Wide Visible Full-Free Lift Three-Stage Mast (FSV)	3700	2385	4305	4620	1780*	1465*	7	11	1500	1500
	4000	2575	4605	4920	1970*	1655*	7	11	1500	1500
	3700	1775	4345	4620	1130*	855*	7	5	1400	1400
	4000	1875	4645	4920	1230*	955*	7	5	1400	1400
	4300	1975	4945	5220	1330*	1055*	7	5	1400	1400
	4500	2045	5145	5420	1400*	1125*	7	5	1350	1350
	4700	2125	5345	5620	1480*	1205*	7	5	1350	1350
	5000	2225	5645	5920	1580*	1305*	7	5	1200	1300
5500	2385	6145	6420	1740*	1465*	7	5	1100	1250	
6000	2575	6645	6920	1930*	1655*	7	5	900	1100	

NOTE: Height of standard load backrest is 920 mm.
* with optional tire sized 6.50-10-12PR, free lift is 20mm longer.

1,750 kg

MAIN VEHICLE SPECIFICATIONS

1	Manufacturer			TOYOTA	TOYOTA	1
2	Model			8FB18	8FBH18	2
3	Load Capacity		kg	1750	1750	3
4	Load Center		mm	500	500	4
5	Power Type			Battery	Battery	5
6	Operator Position			Rider Seated	Rider Seated	6
7	Tire Type		Front/Rear	Pneumatic	Pneumatic	7
8	Wheels (x = driven)		Front/Rear	2x/2	2x/2	8
9	Maximum Fork Height (MFH)		mm	3000	3000	9
10	Free Lift		mm	145	145	10
13	Fork Size		L x W x T	1070/100/35	1070/100/35	13
	Lateral Fork Adjustment		MAX./MIN.	920/200	920/200	
14	Tilt Range		FWD/BWD	deg	7/11	14
15	Length to Fork Face		mm	2115	2115	15
16	Overall Width		mm	1115	1115	16
17	Mast Lowered Height		mm	1970	1970	17
18	Mast Extended Height		mm	4220	4220	18
19	Overhead Guard Height		mm	2025	2105	19
21	Turning Radius (Outside)		mm	1780	1780	21
22	Load Distance (Centerline of front axle to front face of forks)		mm	405	405	22
	Rear Overhang		mm	300	300	
23	Basic Right Angle Stacking Aisle Width (Add load length and clearance)		mm	2185	2185	23
	Intersecting Aisle Width		mm	1775	1775	
24		Travel, Max. (FWD/RVS)	Full Load	km/h	14.5/14.5	24
			No Load	km/h	17.0/17.0	
25	Speeds *	Lifting	Full Load	mm/sec	370	25
			No Load	mm/sec	650	
26		Lowering	Full Load	mm/sec	500	26
			No Load	mm/sec	550	
27	Drawbar Pull *	Full Load/ No Load	3-Minute Ratings	N (kg)	9240/8620(940/870)	27
			5-Minute Ratings	N (kg)	9240/8620(940/870)	
			60-Minute Ratings	N (kg)	2750/2940(280/300)	2750/2940(280/300)
29	Gradeability *	Full Load/ No Load	3-Minute Ratings	% (tanθ)	18/23	29
			5-Minute Ratings	% (tanθ)	18/23	
			30-Minute Ratings	% (tanθ)	11/18	11/18
32	Total Weight	Without Battery	kg	2310	2355	32
33	Weight Distribution (With STD Battery)	Full Load	Front	kg	4240	33
			Rear	kg	500	620
34		No Load	Front	kg	1370	34
			Rear	kg	1620	1740
35		Number	Front/Rear		2/2	35
36	Tires	Size	Front		21X8-9-10PR (I)	36
37			Rear		5.00-8-10PR (I)	5.00-8-10PR (I)
38	Wheelbase		mm	1410	1410	38
39	Tread		Front	mm	920	39
			Rear	mm	895	895
	Backrest Height		mm	1220	1220	
	Overhead Guard Clearance		mm	1035	1035	
	Counterweight Height		mm	1105	1140	
	Drawbar Height		mm	430	430	
	Step Height/Floor Height		mm	430/615	430/695	
40	Underclearance	Mast (Full Load)		mm	65	40
41		Center of Wheelbase (Full Load)		mm	85	41
		Drive Axle (Full Load)		mm	65	
		Steer Axle (No Load)		mm	125	
		Counterweight (No Load)		mm	120	
		Minimum Under Clearance (Full Load)		mm	65(Mast)	65(Mast)
	Grade Clearance	Frame		% (tanθ)	27	
		Counterweight		% (tanθ)	54	
42	Brake	Service (Foot)			Hydraulic	42
43		Parking			Hand	43
45	Battery	Voltage/Capacity (5-hour rating)	STD	V/AH	48/400	45
		High	V/AH	48/485	-	
46	Weight (STD Capacity Type)		kg	680	845	46
47	Electric Motors	Drive		kW	7.6	47
48		Load Handling		kW	9.5	48
		Energy Consumption According to VDI Cycle **		kWh/h	4.2	4.3
54	Control Type	Drive			Trasistor inverter	54
		Load Handling			Trasistor inverter	Trasistor inverter
57	Operating Pressure	For Attachments	Mpa (psi)	11.8(1700)	11.8(1700)	57
	Sound level at the driver's ear according to EN12053 Uncertainty 4dB(A)		dB (A)	68	68	
	Vibration in accordance with in EN13059		m/s2	1.5	1.5	

NOTE: * Computed values.

** 60 VDI circles/h with Tested Load of 1750 kg.

8FB18/8FBH18

DIMENSIONAL DRAWINGS

Unit: mm
[] for 8FBH18

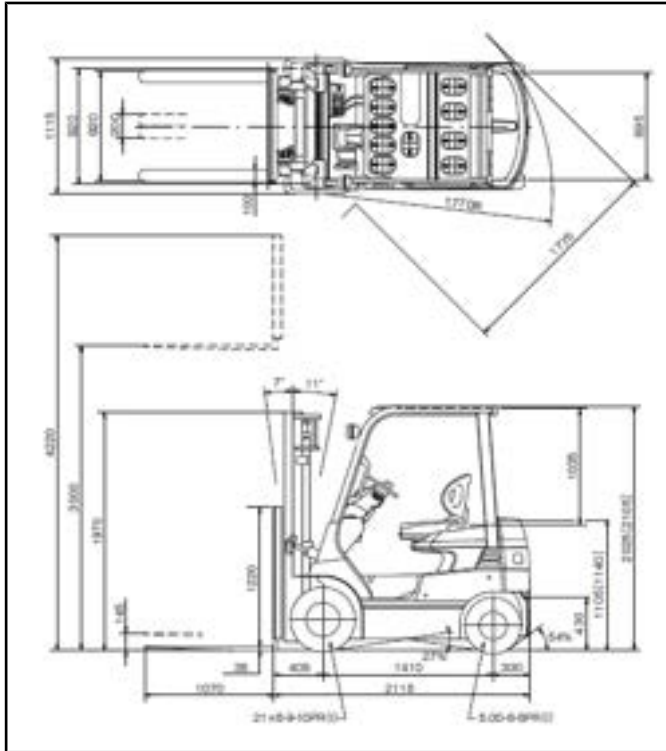

UNDERCLEARANCE

Unit: mm

Mast (Full Load)	65
Center of Wheelbase (Full Load)	85
Drive Axle (Full Load)	65
Steer Axle (No Load)	125
Counterweight (No Load)	120
Minimum Under Clearance (Full Load)	65(Mast)

RATED CAPACITIES

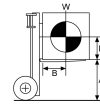

A: Max. Fork Height
B: Load Center
W: Capacity

V, FV Mast

Unit: kg (W)

A (mm)		3000	3300	3500	3700	4000	4500	5000
Single	500	1750	1750	1750	1750	1750	1550	1200
	600	1570	1570	1570	1570	1570	1390	1080
	700	1430	1430	1430	1430	1430	1260	980
	800	1310	1310	1310	1310	1310	1160	900
	900	1210	1210	1210	1210	1210	1070	830
	1000	1120	1120	1120	1120	1120	990	770
	1100	1050	1050	1050	1050	1050	930	720
Dual	1200	980	980	980	980	980	870	670
	500	1750	1750	1750	1750	1750	1650	1550
	600	1570	1570	1570	1570	1570	1480	1390
	700	1430	1430	1430	1430	1430	1350	1260
	800	1310	1310	1310	1310	1310	1230	1160
	900	1210	1210	1210	1210	1210	1140	1070
	1000	1120	1120	1120	1120	1120	1060	990
1100	1050	1050	1050	1050	1050	990	930	
1200	980	980	980	980	980	930	870	

FSV Mast

Unit: kg (W)

A (mm)		3700	4000	4300	4500	4700	5000	5500	6000
Single	500	1600	1600	1550	1500	1500	1250	900	750
	600	1440	1440	1390	1350	1350	1120	810	670
	700	1310	1310	1270	1230	1230	1020	730	610
	800	1200	1200	1170	1130	1130	940	670	560
	900	1110	1110	1080	1040	1040	870	620	520
	1000	1030	1030	1000	970	970	810	580	480
	1100	970	970	930	900	900	750	540	450
Dual	1200	910	910	880	850	850	710	510	420
	500	1600	1600	1550	1500	1500	1450	1400	1150
	600	1440	1440	1390	1350	1350	1300	1260	1030
	700	1310	1310	1270	1230	1230	1190	1150	940
	800	1200	1200	1170	1130	1130	1090	1050	860
	900	1100	1100	1080	1040	1040	1010	970	800
	1000	1030	1030	1000	970	970	940	900	740
1100	970	970	930	900	900	870	840	690	
1200	910	910	880	850	850	820	790	650	

MAST SPECIFICATIONS & RATED CAPACITIES

Mast Type	Maximum Fork Height	Overall Height			Free Lift		Tilt Range		Load Capacity at 500 mm LC	
		Lowered	Extended		Without Load Backrest	With Standard Load Backrest	FWD	BWD	PN	PSC
			Without Load Backrest	With Standard Load Backrest						
mm		mm	mm	mm	mm	mm	deg	deg	kg	kg
Wide Visible Mast (V)	2500	1720	3105	3420	145	145	7	11	1750	1750
	2700	1820	3305	3620	145	145	7	11	1750	1750
	3000	1970	3605	3920	145	145	7	11	1750	1750
	3300	2120	3905	4220	145	145	7	11	1750	1750
	3500	2220	4105	4420	145	145	7	11	1750	1750
	3700	2380	4305	4620	145	145	7	11	1750	1750
	4000	2570	4605	4920	145	145	7	5<11>	1750	1750
	4500	2820	5105	5420	145	145	7	5	1550	1650
	5000	3070	5605	5920	145	145	7	5	1200	1550
Wide Visible Full-Free Lift Two-Stage Mast (FV)	3000	1970	3565	3920	1405*	1050*	7	11	1750	1750
	3300	2120	3865	4220	1555*	1200*	7	11	1750	1750
	3500	2220	4065	4420	1655*	1300*	7	11	1750	1750
	3700	2380	4265	4620	1815*	1460*	7	11	1750	1750
	4000	2570	4565	4920	2005*	1650*	7	5<11>	1750	1750
Wide Visible Full-Free Lift Three-Stage Mast (FSV)	3700	1770	4240	4620	1235*	850*	7	5	1600	1600
	4000	1870	4540	4920	1335*	950*	7	5	1600	1600
	4300	1970	4840	5220	1435*	1050*	7	5	1550	1550
	4500	2040	5040	5420	1505*	1120*	7	5	1500	1500
	4700	2120	5240	5620	1585*	1200*	7	5	1500	1500
	5000	2220	5540	5920	1685*	1300*	7	5	1250	1450
	5500	2380	6040	6420	1845*	1460*	7	5	900	1400
6000	2570	6540	6920	2035*	1650*	7	5	750	1150	

NOTE: Height of standard load backrest is 920 mm.
* with optional tire sized 6.50-10-12PR, free lift is 25mm longer.
< > for PN tires.

2,000 kg

MAIN VEHICLE SPECIFICATIONS

1	Manufacturer			TOYOTA	TOYOTA	1	
2	Model			8FB20	8FBH20	2	
3	Load Capacity		kg	2000	2000	3	
4	Load Center		mm	500	500	4	
5	Power Type			Battery	Battery	5	
6	Operator Position			Rider Seated	Rider Seated	6	
7	Tire Type		Front/Rear	Pneumatic	Pneumatic	7	
8	Wheels (x = driven)		Front/Rear	2x/2	2x/2	8	
9	Maximum Fork Height (MFH)		mm	3000	3000	9	
10	Free Lift		mm	125	125	10	
13	Fork Size		L x W x T	1070/120/36	1070/120/36	13	
	Lateral Fork Adjustment		MAX./MIN.	1020/240	1020/240		
14	Tilt Range		FWD/BWD	7/11	7/11	14	
15	Length to Fork Face		mm	2240	2240	15	
16	Overall Width		mm	1160	1160	16	
17	Mast Lowered Height		mm	1975	1975	17	
18	Mast Extended Height		mm	4220	4220	18	
19	Overhead Guard Height		mm	2025	2105	19	
21	Turning Radius (Outside)		mm	1980	1980	21	
22	Load Distance (Centerline of front axle to front face of forks)		mm	420	420	22	
	Rear Overhang		mm	320	320		
23	Basic Right Angle Stacking Aisle Width (Add load length and clearance)		mm	2400	2400	23	
	Intersecting Aisle Width		mm	1850	1850		
24	Travel, Max. (FWD/RVS)	Full Load	km/h	14.5/14.5	14.5/14.5	24	
		No Load	km/h	16.5/16.5	16.5/16.5		
25	Lifting	Full Load	mm/sec	360	360	25	
		No Load	mm/sec	600	600		
26	Lowering	Full Load	mm/sec	500	500	26	
		No Load	mm/sec	500	500		
27	Drawbar Pull *	Full Load/No Load	3-Minute Ratings N (kg)	11260/10640 (1140/1080)	11210/10600 (1140/1080)	27	
			5-Minute Ratings N (kg)	11260/10640 (1140/1080)	11210/10600 (1140/1080)		
			60-Minute Ratings N (kg)	4710/4900 (480/500)	4710/4900 (480/500)		
29	Gradeability *	Full Load/No Load	3-Minute Ratings % (tanθ)	22/23	20/23	29	
			5-Minute Ratings % (tanθ)	22/23	20/23		
			30-Minute Ratings % (tanθ)	15/22	15/22		
32	Total Weight	Without Battery	kg	2570	2590	32	
33	Weight Distribution (With STD Battery)	Full Load	Front	kg	4790	4980	33
			Rear	kg	530	770	
34	No Load	Front	kg	1560	1750	34	
		Rear	kg	1760	2000		
35	Number	Front/Rear		2/2	2/2	35	
36	Tires	Front		21X8-9-14PR (I)	21X8-9-14PR (I)	36	
37		Size	Rear		18X7-8-14PR (I)	18X7-8-14PR (I)	37
38	Wheelbase		mm	1500	1500	38	
39	Tread	Front	mm	970	970	39	
		Rear	mm	940	940		
	Backrest Height		mm	1220	1220		
	Overhead Guard Clearance		mm	1035	1035		
	Counterweight Height		mm	1100	1135		
	Drawbar Height		mm	425	425		
	Step Height/Floor Height		mm	435/620	435/700		
40	Underclearance	Mast (Full Load)	mm	70	70	40	
41		Center of Wheelbase (Full Load)	mm	90	90	41	
		Drive Axle (Full Load)	mm	70	70		
		Steer Axle (No Load)	mm	120	120		
		Counterweight (No Load)	mm	115	115		
		Minimum Under Clearance (Full Load)	mm	70(Mast)	70(Mast)		
	Grade Clearance	Frame	% (tanθ)	25	25		
		Counterweight	% (tanθ)	56	56		
42	Brake	Service (Foot)		Hydraulic	Hydraulic	42	
43		Parking		Hand	Hand	43	
45	Battery	Voltage/Capacity (5-hour rating)	STD	V/AH	48/450	48/730	45
			High	V/AH	48/600	-	
46	Weight (STD Capacity Type)		kg	750	1160	46	
47	Electric Motors	Drive	kW	10.7	10.7	47	
48		Load Handling	kW	12.2	12.2	48	
		Energy Consumption According to VDI Cycle **	kWh/h	4.1	4.2		
54	Control Type	Drive		Transistor inverter	Transistor inverter	54	
		Load Handling		Transistor inverter	Transistor inverter		
57	Operating Pressure	For Attachments	Mpa (psi)	14.7(2100)	14.7(2100)	57	
	Sound level at the driver's ear according to EN12053 Uncertainty 4dB(A)		dB(A)	67	67		
	Vibration in accordance with in EN13059		m/s2	1.5	1.5		

NOTE: * Computed values.

** 60 VDI circles/h with Tested Load of 2000 kg.

DIMENSIONAL DRAWINGS

Unit: mm
[] for 8FBH20

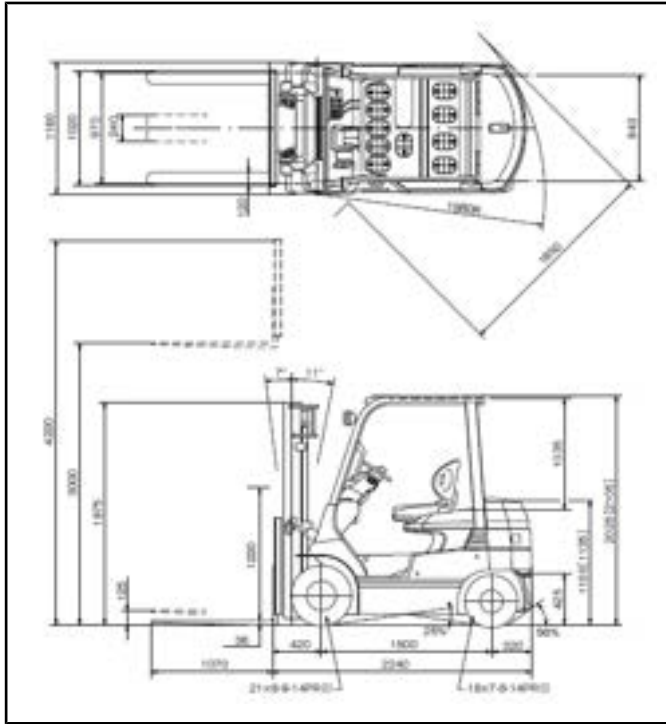

UNDERCLEARANCE

Mast (Full Load)	70
Center of Wheelbase (Full Load)	90
Drive Axle (Full Load)	70
Steer Axle (No Load)	120
Counterweight (No Load)	115
Minimum Under Clearance (Full Load)	70(Mast)

RATED CAPACITIES

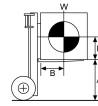

A: Max. Fork Height
B: Load Center
W: Capacity

V, FV Mast

Unit: kg (W)

A (mm)		3000	3300	3500	3700	4000	4500	5000
Single	500	2000	2000	2000	2000	2000	1900	1650
	600	1800	1800	1800	1800	1800	1710	1480
	700	1640	1640	1640	1640	1640	1560	1350
	800	1500	1500	1500	1500	1500	1430	1240
	900	1390	1390	1390	1390	1390	1320	1150
	1000	1290	1290	1290	1290	1290	1230	1060
	1100	1210	1210	1210	1210	1210	1150	990
Dual	1200	1130	1130	1130	1130	1130	1070	930
	1300	1070	1070	1070	1070	1070	1010	880
	500	2000	2000	2000	2000	2000	1900	1800
	600	1800	1800	1800	1800	1800	1710	1620
	700	1640	1640	1640	1640	1640	1560	1470
	800	1500	1500	1500	1500	1500	1430	1350
	900	1390	1390	1390	1390	1390	1320	1250
Dual	1000	1290	1290	1290	1290	1290	1230	1160
	1100	1210	1210	1210	1210	1210	1150	1080
	1200	1130	1130	1130	1130	1130	1070	1020
	1300	1070	1070	1070	1070	1070	1010	960

FSV Mast

Unit: kg (W)

A (mm)		3700	4000	4300	4500	4700	5000	5500	6000
Single	500	1900	1900	1850	1800	1800	1550	1200	900
	600	1710	1710	1670	1620	1620	1400	1080	810
	700	1560	1560	1520	1480	1480	1270	990	740
	800	1440	1440	1400	1360	1360	1170	910	680
	900	1330	1330	1300	1260	1260	1090	840	630
	1000	1240	1240	1210	1170	1170	1010	780	580
	1100	1160	1160	1130	1100	1100	940	730	550
Dual	1200	1090	1090	1060	1030	1030	890	690	510
	1300	1030	1030	1000	970	970	840	650	480
	500	1900	1900	1850	1800	1800	1750	1700	1500
	600	1710	1710	1670	1620	1620	1580	1530	1350
	700	1560	1560	1520	1480	1480	1440	1400	1230
	800	1440	1440	1400	1360	1360	1320	1290	1130
	900	1330	1330	1300	1260	1260	1230	1190	1050
Dual	1000	1240	1240	1210	1170	1170	1140	1110	980
	1100	1160	1160	1130	1100	1100	1070	1040	910
	1200	1090	1090	1060	1030	1030	1000	970	860
	1300	1030	1030	1000	970	970	940	920	810

MAST SPECIFICATIONS & RATED CAPACITIES

Mast Type	Maximum Fork Height	Overall Height			Free Lift		Tilt Range		Load Capacity at 500 mm LC	
		Lowered	Extended		Without Load Backrest	With Standard Load Backrest	FWD	BWD	PN	PSC
			Without Load Backrest	With Standard Load Backrest						
Wide Visible Mast (V)	2500	1725	3170	3420	125	125	7	11	2000	2000
	2700	1825	3370	3620	125	125	7	11	2000	2000
	3000	1975	3670	3920	125	125	7	11	2000	2000
	3300	2125	3970	4220	125	125	7	11	2000	2000
	3500	2225	4170	4420	125	125	7	11	2000	2000
	3700	2385	4370	4620	125	125	7	11	2000	2000
	4000	2575	4670	4920	125	125	7	11	2000	2000
	4500	2825	5170	5420	125	125	7	5	1900	1900
Wide Visible Full-Free Lift Two-Stage Mast (FV)	5000	3075	5670	5920	125	125	7	5	1650	1800
	3000	1975	3605	3920	1370*	1055*	7	11	2000	2000
	3300	2125	3905	4220	1520*	1205*	7	11	2000	2000
	3500	2225	4105	4420	1620*	1305*	7	11	2000	2000
	3700	2385	4305	4620	1780*	1465*	7	11	2000	2000
Wide Visible Full-Free Lift Three-Stage Mast (FSV)	4000	2575	4605	4920	1970*	1655*	7	11	2000	2000
	3700	1775	4345	4620	1130*	855*	7	5	1900	1900
	4000	1875	4645	4920	1230*	955*	7	5	1900	1900
	4300	1975	4945	5220	1330*	1055*	7	5	1850	1850
	4500	2045	5145	5420	1400*	1125*	7	5	1800	1800
	4700	2125	5345	5620	1480*	1205*	7	5	1800	1800
	5000	2225	5645	5920	1580*	1305*	7	5	1550	1750
5500	2385	6145	6420	1740*	1465*	7	5	1200	1700	
6000	2575	6645	6920	1930*	1655*	7	5	900	1500	

NOTE: Height of standard load backrest is 920 mm.
* with optional tire sized 6.50-10-12PR, free lift is 20mm longer.

2,000 kg

MAIN VEHICLE SPECIFICATIONS

1	Manufacturer			TOYOTA	1		
2	Model			40-8FB20	2		
3	Load Capacity		kg	2000	3		
4	Load Center		mm	500	4		
5	Power Type			Battery	5		
6	Operator Position			Rider Seated	6		
7	Tire Type		Front/Rear	Pneumatic	7		
8	Wheels (x = driven)		Front/Rear	2x/2	8		
9	Maximum Fork Height (MFH)		mm	3000	9		
10	Free Lift		mm	150	10		
13	Fork Size		L x W x T	1070/120/36	13		
	Fork Spread (Outside)		MAX./MIN.	1020/240			
14	Tilt Range		FWD/BWD	6/11	14		
15	Length to Fork Face		mm	2405	15		
16	Overall Width		mm	1230	16		
17	Mast Lowered Height		mm	1995	17		
18	Mast Extended Height		mm	4220	18		
19	Overhead Guard Height		mm	2160	19		
21	Turning Radius (Outside)		mm	2145	21		
22	Load Distance (Centerline of front axle to front face of forks)		mm	445	22		
	Rear Overhang		mm	310			
23	Basic Right Angle Stacking Aisle Width (Add load length and clearance)		mm	2590	23		
	Intersecting Aisle Width		mm	1910			
24	Speeds *	Travel, Max. (FWD/RVS)	Full Load	km/h	14.5/14.5	24	
			No Load	km/h	15.5/15.5		
		Lowering	Full Load/No Load	Full Load	mm/sec	360	25
				No Load	mm/sec	600	
26			Full Load/No Load	mm/sec	500/500	26	
27	Drawbar Pull *	Full Load/No Load	3-Minute Ratings	N (kg)	12650/11980 (1290/1220)	27	
			5-Minute Ratings	N (kg)	12650/11980 (1290/1220)		
			60-Minute Ratings	N (kg)	5300/5390 (540/550)		
29	Gradeability *	Full Load/No Load	3-Minute Ratings	% (tanθ)	21/24	29	
			5-Minute Ratings	% (tanθ)	21/24		
			30-Minute Ratings	% (tanθ)	14/21		
32	Total Weight	Without Battery		kg	2890	32	
33	Weight Distribution (With STD Battery)	Full Load	Front	kg	5160	33	
			Rear	kg	1050		
34		No Load	Front	kg	2010	34	
			Rear	kg	2200		
35	Tires	Number	Front/Rear		2/2	35	
36		Size	Front		7.00-12-12PR (I)	36	
37			Rear		6.00-9-10PR (I)	37	
38	Wheelbase		mm	1650	38		
39	Tread	Front	mm	960	39		
		Rear	mm	965			
	Backrest Height			1220			
	Overhead Guard Clearance			1035			
	Counterweight Height			1195			
	Drawbar Height			505			
	Step Height/Floor Height			490/755			
40	Underclearance	Mast (Full Load)		mm	85	40	
41		Center of Wheelbase (Full Load)		mm	110	41	
		Drive Axle (Full Load)		mm	125		
		Steer Axle (No Load)			150		
		Counterweight (No Load)		mm	160		
		Minimum Under Clearance (Full Load)		mm	85(Mast)		
	Grade Clearance	Frame	% (tanθ)	29			
		Counterweight	% (tanθ)	96			
42	Brake	Service (Foot)			Hydraulic	42	
43		Parking			Hand	43	
45	Battery	Voltage/Capacity (5-hour rating)	STD	V/AH	48/845	45	
			High	V/AH	-		
46	Weight (STD Capacity Type)		kg	1320	46		
47	Electric Motors	Drive		kW	10.7	47	
		Load Handling		kW	12.2	48	
		Energy Consumption According to VDI Cycle **		kWh/h	4.2		
54	Control Type	Drive			Transistor inverter	54	
		Load Handling			Transistor inverter		
57	Operating Pressure		For Attachments	Mpa (psi)	14.7 (2100)	57	
	Sound level at the driver's ear according to EN12053 Uncertainty 4dB(A)			dB (A)	-		
	Vibration in accordance with in EN13059			m/s2	-		

NOTE: * Computed values.

** 60 VDI circles/h with Tested Load of 2000 kg.

DIMENSIONAL DRAWINGS

Unit: mm

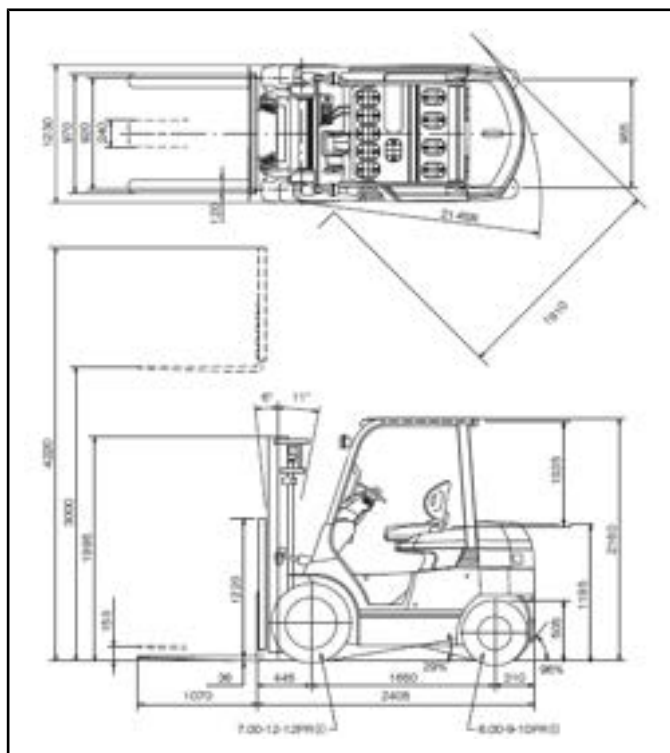

UNDERCLEARANCE

Mast (Full Load)	85
Center of Wheelbase (Full Load)	110
Drive Axle (Full Load)	125
Steer Axle (No Load)	150
Counterweight (No Load)	160
Minimum Under Clearance (No Load)	85(Mast)

RATED CAPACITIES

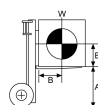

A: Max. Fork Height
B: Load Center
W: Capacity

V, FV Mast

Unit: kg (W)

A (mm)		3000	3300	3500	3700	4000	4500	5000
Single	500	2000	2000	2000	2000	2000	1900	1650
	600	1810	1810	1810	1810	1810	1720	1490
	700	1650	1650	1650	1650	1650	1570	1360
	800	1520	1520	1520	1520	1520	1440	1250
	900	1410	1410	1410	1410	1410	1340	1160
	1000	1310	1310	1310	1310	1310	1250	1080
	1100	1230	1230	1230	1230	1230	1170	1010
Dual	1200	1150	1150	1150	1150	1150	1090	950
	1300	1090	1090	1090	1090	1090	1030	900
	500	2000	2000	2000	2000	2000	1900	1800
	600	1810	1810	1810	1810	1810	1720	1630
	700	1650	1650	1650	1650	1650	1570	1490
	800	1520	1520	1520	1520	1520	1440	1370
	900	1410	1410	1410	1410	1410	1340	1270
Dual	1000	1310	1310	1310	1310	1310	1250	1180
	1100	1230	1230	1230	1230	1230	1170	1100
	1200	1150	1150	1150	1150	1150	1090	1040
	1300	1090	1090	1090	1090	1090	1030	980

FSV Mast

Unit: kg (W)

A (mm)		3700	4000	4300	4500	4700	5000	5500	6000
Single	500	1900	1900	1850	1800	1800	1550	1200	900
	600	1720	1720	1670	1630	1630	1400	1080	810
	700	1570	1570	1530	1490	1490	1280	990	740
	800	1450	1450	1410	1370	1370	1180	910	680
	900	1340	1340	1310	1270	1270	1100	850	630
	1000	1250	1250	1220	1190	1190	1020	790	590
	1100	1170	1170	1140	1110	1110	960	740	550
Dual	1200	1100	1100	1070	1040	1040	900	690	520
	1300	1040	1040	1010	990	990	850	660	490
	500	1900	1900	1850	1800	1800	1750	1700	1500
	600	1720	1720	1670	1630	1630	1580	1540	1360
	700	1570	1570	1530	1490	1490	1450	1410	1240
	800	1450	1450	1410	1370	1370	1330	1300	1140
	900	1340	1340	1310	1270	1270	1240	1200	1060
Dual	1000	1250	1250	1220	1190	1190	1150	1120	990
	1100	1170	1170	1140	1110	1110	1080	1050	930
	1200	1100	1100	1070	1040	1040	1020	990	870
	1300	1040	1040	1010	990	990	960	930	820

MAST SPECIFICATIONS & RATED CAPACITIES

Mast Type	Maximum Fork Height	Overall Height			Free Lift		Tilt Range		Load Capacity at 500 mm LC	
		Lowered	Extended		Without Load Backrest	With Standard Load Backrest	FWD	BWD	PN	PSC
			Without Load Backrest	With Standard Load Backrest						
Wide Visible Mast (V)	2500	1745	3160	3420	150	150	6	11	2000	2000
	2700	1845	3360	3620	150	150	6	11	2000	2000
	3000	1995	3660	3920	150	150	6	11	2000	2000
	3300	2145	3960	4220	150	150	6	11	2000	2000
	3500	2245	4160	4420	150	150	6	11	2000	2000
	3700	2405	4360	4620	150	150	6	11	2000	2000
	4000	2595	4660	4920	150	150	6	11	2000	2000
	4500	2845	5160	5420	150	150	6	6	1900	1900
Wide Visible Full-Free Lift Two-Stage Mast (FV)	5000	3095	5660	5920	150	150	6	6	1650	1800
	3000	1995	3600	3920	1395	1075	6	11	2000	2000
	3300	2145	3900	4220	1545	1225	6	11	2000	2000
	3500	2245	4100	4420	1645	1325	6	11	2000	2000
	3700	2405	4300	4620	1805	1485	6	11	2000	2000
Wide Visible Full-Free Lift Three-Stage Mast (FSV)	4000	2595	4600	4920	1995	1675	6	11	2000	2000
	3700	1795	4270	4620	1225	875	6	6	1900	1900
	4000	1895	4570	4920	1325	975	6	6	1900	1900
	4300	1995	4870	5220	1425	1075	6	6	1850	1850
	4500	2065	5070	5420	1495	1145	6	6	1800	1800
	4700	2145	5270	5620	1575	1225	6	6	1800	1800
	5000	2245	5570	5920	1675	1325	6	6	1550	1750
5500	2405	6070	6420	1835	1485	6	6	1200	1700	
6000	2595	6570	6920	2025	1675	6	6	900	1500	

NOTE: Height of standard load backrest is 920 mm.

2,500 kg

MAIN VEHICLE SPECIFICATIONS

1	Manufacturer			TOYOTA	TOYOTA	1
2	Model			8FB25	8FBH25	2
3	Load Capacity		kg	2500	2500	3
4	Load Center		mm	500	500	4
5	Power Type			Battery	Battery	5
6	Operator Position			Rider Seated	Rider Seated	6
7	Tire Type		Front/Rear	Pneumatic	Pneumatic	7
8	Wheels (x = driven)		Front/Rear	2x/2	2x/2	8
9	Maximum Fork Height (MFH)		mm	3000	3000	9
10	Free Lift		mm	130	130	10
13	Fork Size		L x W x T	1070/120/40	1070/120/40	13
	Lateral Fork Adjustment		MAX./MIN.	1020/240	1020/240	
14	Tilt Range		FWD/BWD	7/11	7/11	14
15	Length to Fork Face		mm	2290	2290	15
16	Overall Width		mm	1160	1160	16
17	Mast Lowered Height		mm	1975	1975	17
18	Mast Extended Height		mm	4220	4220	18
19	Overhead Guard Height		mm	2025	2105	19
21	Turning Radius (Outside)		mm	2000	2000	21
22	Load Distance (Centerline of front axle to front face of forks)		mm	435	435	22
	Rear Overhang		mm	355	355	
23	Basic Right Angle Stacking Aisle Width (Add load length and clearance)		mm	2430	2430	23
	Intersecting Aisle Width		mm	1875	1875	
24	Speeds *	Travel, Max. (FWD/RVS)	Full Load	km/h	14.0/14.0	14.0/14.0
			No Load	km/h	16.0/16.0	16.0/16.0
		Lifting	Full Load	mm/sec	340	340
			No Load	mm/sec	600	600
26	Lowering	Full Load	mm/sec	500	500	26
		No Load	mm/sec	500	500	
27	Drawbar Pull *	Full Load/ No Load	3-Minute Ratings	N (kg)	11090/10560 (1130/1070)	11060/11530 (1120/1170)
			5-Minute Ratings	N (kg)	11090/10560 (1130/1070)	11060/11530 (1120/1170)
			60-Minute Ratings	N (kg)	4510/4810 (460/490)	4510/4810 (460/490)
29	Gradeability *	Full Load/ No Load	3-Minute Ratings	% (tanθ)	18/20	17/21
			5-Minute Ratings	% (tanθ)	18/20	17/21
			30-Minute Ratings	% (tanθ)	12/20	12/20
32	Total Weight	Without Battery	kg	2960	2960	32
33	Weight Distribution (With STD Battery)	Full Load	Front	kg	5630	5800
			Rear	kg	710	820
34	No Load	Front	kg	1570	1740	34
		Rear	kg	2270	2380	
35	Tires	Number	Front/Rear	2/2	2/2	35
36	Size	Front		21X8-9-14PR (I)	21X8-9-14PR (I)	36
37		Rear		18X7-8-14PR (I)	18X7-8-14PR (I)	
38	Wheelbase		mm	1500	1500	38
39	Tread	Front	mm	970	970	39
		Rear	mm	940	940	
	Backrest Height		mm	1220	1220	
	Overhead Guard Clearance		mm	1035	1035	
	Counterweight Height		mm	1125	1135	
	Drawbar Height		mm	280	280	
	Step Height/Floor Height		mm	435/620	435/700	
40	Underclearance	Mast (Full Load)		mm	65	65
41		Center of Wheelbase (Full Load)		mm	85	85
		Drive Axle (Full Load)		mm	65	65
		Steer Axle (No Load)		mm	120	120
		Counterweight (No Load)		mm	115	115
		Minimum Under Clearance (Full Load)		mm	65(Mast)	65(Mast)
	Grade Clearance	Frame	% (tanθ)	25	25	49
		Counterweight	% (tanθ)	49	49	
42	Brake	Service (Foot)			Hydraulic	Hydraulic
43		Parking			Hand	Hand
45	Battery	Voltage/Capacity (5-hour rating)	STD	V/AH	48/565	48/730
		High	V/AH	48/600	-	
46	Weight (STD Capacity Type)		kg	880	1160	46
47	Electric Motors	Drive		kW	10.7	10.7
48		Load Handling		kW	12.2	12.2
		Energy Consumption According to VDI Cycle **		kWh/h	4.5	4.6
54	Control Type	Drive			Transistor inverter	Transistor inverter
		Load Handling			Transistor inverter	Transistor inverter
57	Operating Pressure	For Attachments	Mpa (psi)	14.7(2100)	14.7(2100)	57
	Sound level at the driver's ear according to EN12053 Uncertainty 4dB(A)		dB(A)	67	67	
	Vibration in accordance with in EN13059		m/s2	1.5	1.5	

NOTE: * Computed values.

** 60 VDI Work Cycles/h with Tested Load of 2500 kg

DIMENSIONAL DRAWINGS

Unit: mm
[] for 8FBH25

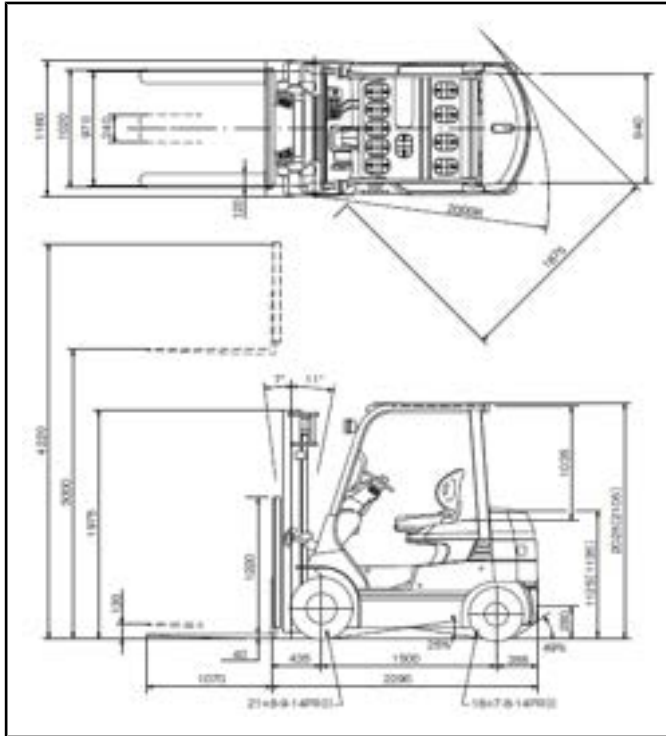

UNDERCLEARANCE

Mast (Full Load)	65
Center of Wheelbase (Full Load)	85
Drive Axle (Full Load)	65
Steer Axle (No Load)	120
Counterweight (No Load)	115
Minimum Under Clearance (No Load)	65(Mast)

RATED CAPACITIES

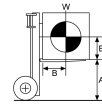

A: Max. Fork Height
B: Load Center
W: Capacity

V, FV Mast

Unit: kg (W)

A (mm)		3000	3300	3500	3700	4000	4500	5000
Single	500	2500	2500	2500	2500	2500	2300	1800
	600	2250	2250	2250	2250	2250	2070	1620
	700	2050	2050	2050	2050	2050	1890	1480
	800	1890	1890	1890	1890	1890	1730	1360
	900	1740	1740	1740	1740	1740	1600	1250
	1000	1620	1620	1620	1620	1620	1490	1170
	1100	1520	1520	1520	1520	1520	1390	1090
Dual	1200	1420	1420	1420	1420	1420	1310	1020
	1300	1340	1340	1340	1340	1340	1230	960
	500	2500	2500	2500	2500	2500	2450	2350
	600	2250	2250	2250	2250	2250	2210	2120
	700	2050	2050	2050	2050	2050	2010	1930
	800	1890	1890	1890	1890	1890	1850	1770
	900	1740	1740	1740	1740	1740	1710	1640
1000	1620	1620	1620	1620	1620	1590	1520	
1100	1520	1520	1520	1520	1520	1490	1420	
1200	1420	1420	1420	1420	1420	1390	1340	
1300	1340	1340	1340	1340	1340	1310	1260	

V, FV Mast

Unit: kg (W)

A (mm)		3700	4000	4300	4500	4700	5000	5500	6000
Single	500	2400	2400	2300	2050	2050	1650	1250	1000
	600	2170	2170	2080	1850	1850	1490	1130	900
	700	1980	1980	1900	1690	1690	1360	1030	820
	800	1820	1820	1750	1560	1560	1250	950	760
	900	1690	1690	1620	1440	1440	1160	880	700
	1000	1570	1570	1510	1340	1340	1080	820	650
	1100	1470	1470	1410	1260	1260	1010	760	610
Dual	1200	1380	1380	1320	1180	1180	950	720	570
	1300	1300	1300	1250	1110	1110	890	680	540
	500	2400	2400	2400	2300	2300	2200	2000	1550
	600	2170	2170	2170	2080	2080	1990	1810	1400
	700	1980	1980	1980	1900	1900	1820	1650	1280
	800	1820	1820	1820	1750	1750	1670	1520	1180
	900	1690	1690	1690	1620	1620	1550	1410	1090
1000	1570	1570	1570	1510	1510	1440	1310	1010	
1100	1470	1470	1470	1410	1410	1350	1230	950	
1200	1380	1380	1380	1320	1320	1270	1150	890	
1300	1300	1300	1300	1250	1250	1190	1090	840	

MAST SPECIFICATIONS & RATED CAPACITIES

Mast Type	Maximum Fork Height	Overall Height			Free Lift		Tilt Range		Load Capacity at 500 mm LC	
		Lowered	Extended		Without Load Backrest	With Standard Load Backrest	FWD	BWD	PN	PSC
			Without Load Backrest	With Standard Load Backrest						
mm	mm	mm	mm	mm	mm	deg	deg	kg	kg	
Wide Visible Mast (V)	2500	1725	3165	3420	130	130	7	11	2500	2500
	2700	1825	3365	3620	130	130	7	11	2500	2500
	3000	1975	3665	3920	130	130	7	11	2500	2500
	3300	2125	3965	4220	130	130	7	11	2500	2500
	3500	2225	4165	4420	130	130	7	11	2500	2500
	3700	2385	4365	4620	130	130	7	11	2500	2500
	4000	2575	4665	4920	130	130	7	5<11>	2500	2500
Wide Visible Full-Free Lift Two-Stage Mast (FV)	4500	2825	5165	5420	130	130	7	5	2300	2450
	5000	3075	5665	5920	130	130	7	5	1800	2350
	3000	1975	3600	3920	1375*	1055*	7	11	2500	2500
	3300	2125	3900	4220	1525*	1205*	7	11	2500	2500
	3500	2225	4100	4420	1625*	1305*	7	11	2500	2500
	3700	2385	4300	4620	1785*	1465*	7	11	2500	2500
	4000	2575	4600	4920	1975*	1655*	7	5<11>	2500	2500
Wide Visible Full-Free Lift Three-Stage Mast (FSV)	3700	1775	4340	4620	1135*	855*	7	5	2400	2400
	4000	1875	4640	4920	1235*	955*	7	5	2400	2400
	4300	1975	4940	5220	1335*	1055*	7	5	2300	2400
	4500	2045	5140	5420	1405*	1125*	7	5	2050	2300
	4700	2125	5340	5620	1485*	1205*	7	5	2050	2300
	5000	2225	5640	5920	1585*	1305*	7	5	1650	2200
	5500	2385	6140	6420	1745*	1465*	7	5	1250	2000
6000	2575	6640	6920	1935*	1655*	7	5	1000	1550	

NOTE: Height of standard load backrest is 920 mm.
* with optional tire sized 6.50-10-12PR, free lift is 20mm longer.
< > for PN tires.

The data in this publication was determined based on our standard testing condition. Operating performance may vary depending on the actual specification and condition of the vehicle as well as the condition of the operating area.

2,500 kg

MAIN VEHICLE SPECIFICATIONS

1	Manufacturer			TOYOTA	1	
2	Model			40-8FB25	2	
3	Load Capacity		kg	2500	3	
4	Load Center		mm	500	4	
5	Power Type			Battery	5	
6	Operator Position			Rider Seated	6	
7	Tire Type		Front/Rear	Pneumatic	7	
8	Wheels (x = driven)		Front/Rear	2x/2	8	
9	Maximum Fork Height (MFH)		mm	3000	9	
10	Free Lift		mm	155	10	
13	Fork Size		L x W x T	1070/120/40	13	
	Fork Spread (Outside)		MAX./MIN.	1020/240		
14	Tilt Range		FWD/BWD	6/11	14	
15	Length to Fork Face		mm	2435	15	
16	Overall Width		mm	1230	16	
17	Mast Lowered Height		mm	1995	17	
18	Mast Extended Height		mm	4220	18	
19	Overhead Guard Height		mm	2160	19	
21	Turning Radius (Outside)		mm	2170	21	
22	Load Distance (Centerline of front axle to front face of forks)		mm	475	22	
	Rear Overhang		mm	310		
23	Basic Right Angle Stacking Aisle Width (Add load length and clearance)		mm	2640	23	
	Intersecting Aisle Width		mm	1915		
24	Speeds *	Travel, Max. (FWD/RVS)	Full Load	km/h	14.5/14.5	24
			No Load	km/h	15.5/15.5	
		Lowering	Full Load	mm/sec	340	25
			No Load	mm/sec	600	
26			Full Load	mm/sec	500	26
			No Load	mm/sec	500	
27	Drawbar Pull *	Full Load/ No Load	3-Minute Ratings	N (kg)	12890/12010 (1310/1220)	27
			5-Minute Ratings	N (kg)	12890/12010 (1310/1220)	
			60-Minute Ratings	N (kg)	5200/5300 (530/540)	
29	Gradeability *	Full Load/ No Load	3-Minute Ratings	% (tanθ)	20/24	29
			5-Minute Ratings	% (tanθ)	20/24	
			30-Minute Ratings	% (tanθ)	13/20	
32	Total Weight	Without Battery	kg	3000	32	
33	Weight Distribution (With STD Battery)	Full Load	Front	kg	6020	33
			Rear	kg	800	
34		No Load	Front	kg	2040	34
			Rear	kg	2280	
35	Tires	Number	Front/Rear	2/2	35	
36		Size	Front	7.00-12-12PR (I)	36	
37			Rear	6.00-9-10PR (I)	37	
38	Wheelbase		mm	1650	38	
39	Tread	Front	mm	960	39	
		Rear	mm	965		
	Backrest Height			1220		
	Overhead Guard Clearance			1035		
	Counterweight Height			1195		
	Drawbar Height			505		
	Step Height/Floor Height			490/755		
40	Underclearance	Mast (Full Load)		mm	75	40
41		Center of Wheelbase (Full Load)		mm	110	41
		Drive Axle (Full Load)		mm	115	
		Steer Axle (No Load)		mm	150	
		Counterweight (No Load)		mm	160	
		Minimum Under Clearance (Full Load)		mm	75(Mast)	
	Grade Clearance	Frame	% (tanθ)	29		
		Counterweight	% (tanθ)	96		
42	Brake	Service (Foot)		Hydraulic	42	
43		Parking		Hand	43	
45	Battery	Voltage/Capacity (5-hour rating)	STD High	V/AH V/AH	48/845 -	45
46		Weight (STD Capacity Type)	kg	1320	46	
47	Electric Motors	Drive	kW	10.7	47	
48		Load Handling	kW	12.2	48	
		Energy Consumption According to VDI Cycle **	kWh/h	4.6		
54	Control Type	Drive		Transistor inverter	54	
		Load Handling		Transistor inverter		
57	Operating Pressure	For Attachments	Mpa (psi)	14.7 (2100)	57	
	Sound level at the driver's ear according to EN12053 Uncertainty 4dB(A)		dB(A)	-		
	Vibration in accordance with in EN13059		m/s2	-		

NOTE: * Computed values.

** 60 VDI circles/h with Tested Load of 2500 kg.

DIMENSIONAL DRAWINGS

Unit: mm

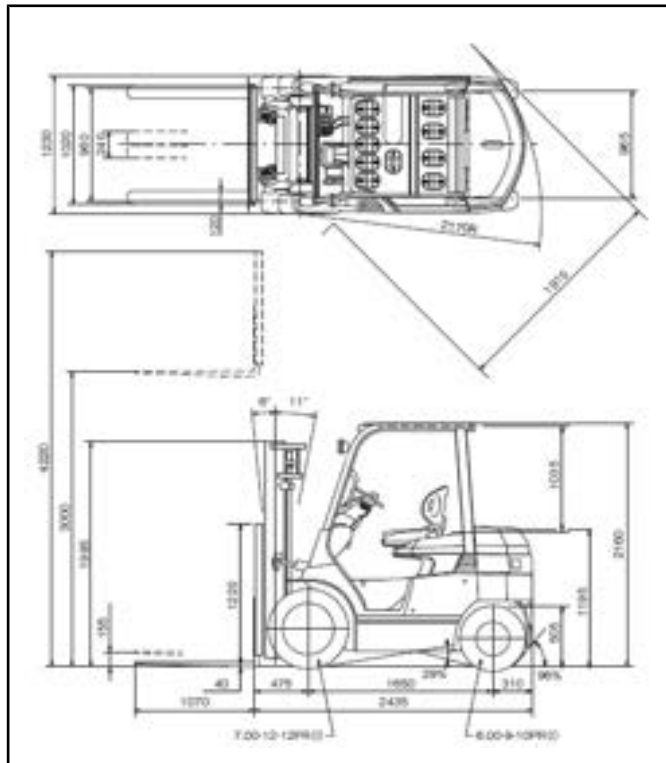

UNDERCLEARANCE

Mast (Full Load)	75
Center of Wheelbase (Full Load)	110
Drive Axle (Full Load)	115
Steer Axle (No Load)	150
Counterweight (No Load)	160
Minimum Under Clearance (No Load)	75(Mast)

RATED CAPACITIES

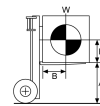

A: Max. Fork Height
B: Load Center
W: Capacity

V, FV Mast

Unit: kg (W)

A (mm)	3000	3300	3500	3700	4000	4500	5000
Single	500	2500	2500	2500	2500	2300	1800
	600	2260	2260	2260	2260	2080	1630
	700	2070	2070	2070	2070	1900	1490
	800	1910	1910	1910	1910	1750	1370
	900	1770	1770	1770	1770	1620	1270
	1000	1650	1650	1650	1650	1510	1180
	1100	1540	1540	1540	1540	1420	1110
Dual	1200	1450	1450	1450	1450	1330	1040
	1300	1370	1370	1370	1370	1260	980
	500	2500	2500	2500	2500	2450	2350
	600	2260	2260	2260	2260	2220	2130
	700	2070	2070	2070	2070	2030	1940
	800	1910	1910	1910	1910	1870	1790
	900	1770	1770	1770	1770	1730	1660
1000	1650	1650	1650	1650	1610	1550	
1100	1540	1540	1540	1540	1510	1450	
1200	1450	1450	1450	1450	1420	1360	
1300	1370	1370	1370	1370	1340	1280	

FSV Mast

Unit: kg (W)

A (mm)	3700	4000	4300	4500	4700	5000	5500	6000	
Single	500	2400	2400	2300	2050	2050	1650	1250	1000
	600	2170	2170	2080	1860	1860	1490	1130	900
	700	1990	1990	1910	1700	1700	1370	1030	830
	800	1840	1840	1760	1570	1570	1260	950	760
	900	1700	1700	1630	1460	1460	1170	890	710
	1000	1590	1590	1520	1360	1360	1090	830	660
	1100	1490	1490	1430	1270	1270	1020	770	620
	1200	1400	1400	1340	1200	1200	960	730	580
	1300	1320	1320	1270	1130	1130	910	690	550
	Dual	500	2400	2400	2400	2300	2300	2200	2000
600		2170	2170	2170	2080	2080	1990	1810	1400
700		1990	1990	1990	1910	1910	1830	1660	1280
800		1840	1840	1840	1760	1760	1680	1530	1180
900		1700	1700	1700	1630	1630	1560	1420	1100
1000		1590	1590	1590	1520	1520	1460	1320	1020
1100		1490	1490	1490	1430	1430	1360	1240	960
1200		1400	1400	1400	1340	1340	1280	1170	900
1300		1320	1320	1320	1270	1270	1210	1100	850

MAST SPECIFICATIONS & RATED CAPACITIES

Mast Type	Maximum Fork Height	Overall Height			Free Lift		Tilt Range		Load Capacity at 500 mm LC	
		Lowered	Extended		Without Load Backrest	With Standard Load Backrest	FWD	BWD	PN	PSC
			Without Load Backrest	With Standard Load Backrest						
Wide Visible Mast (V)	2500	1745	3150	3420	155	155	6	11	2500	2500
	2700	1845	3350	3620	155	155	6	11	2500	2500
	3000	1995	3650	3920	155	155	6	11	2500	2500
	3300	2145	3950	4220	155	155	6	11	2500	2500
	3500	2245	4150	4420	155	155	6	11	2500	2500
	3700	2405	4350	4620	155	155	6	11	2500	2500
	4000	2595	4650	4920	155	155	6	6<11>	2500	2500
	4500	2845	5150	5420	155	155	6	6	2300	2450
Wide Visible Full-Free Lift Two-Stage Mast (FV)	5000	3095	5650	5920	155	155	6	6	1800	2350
	3000	1995	3595	3920	1400	1075	6	11	2500	2500
	3300	2145	3895	4220	1550	1225	6	11	2500	2500
	3500	2245	4095	4420	1650	1325	6	11	2500	2500
	3700	2405	4295	4620	1810	1485	6	11	2500	2500
Wide Visible Full-Free Lift Three-Stage Mast (FSV)	4000	2595	4595	4920	2000	1675	6	6<11>	2500	2500
	3700	1795	4265	4620	1230	875	6	6	2400	2400
	4000	1895	4565	4920	1330	975	6	6	2400	2400
	4300	1995	4865	5220	1430	1075	6	6	2300	2400
	4500	2065	5065	5420	1500	1145	6	6	2050	2300
	4700	2145	5265	5620	1580	1225	6	6	2050	2300
	5000	2245	5565	5920	1680	1325	6	6	1650	2200
	5500	2405	6065	6420	1840	1485	6	6	1250	2000
6000	2595	6565	6920	2030	1675	6	6	1000	1550	

NOTE: Height of standard load backrest is 920 mm.
<> for PN tires.

The data in this publication was determined based on our standard testing condition. Operating performance may vary depending on the actual specification and condition of the vehicle as well as the condition of the operating area.

3,000 kg

MAIN VEHICLE SPECIFICATIONS

1	Manufacturer			TOYOTA	1	
2	Model			8FB30	2	
3	Load Capacity		kg	3000	3	
4	Load Center		mm	500	4	
5	Power Type			Battery	5	
6	Operator Position			Rider Seated	6	
7	Tire Type	Front/Rear		Pneumatic	7	
8	Wheels (x = driven)	Front/Rear		2x/2	8	
9	Maximum Fork Height (MFH)		mm	3000	9	
10	Free Lift		mm	135	10	
13	Fork Size	L x W x T	mm	1070/120/44	13	
	Fork Spread (Outside)	MAX./MIN.	mm	1070/240		
14	Tilt Range	FWD/BWD	deg	6/11	14	
15	Length to Fork Face		mm	2490	15	
16	Overall Width		mm	1240	16	
17	Mast Lowered Height		mm	2020	17	
18	Mast Extended Height		mm	4220	18	
19	Overhead Guard Height		mm	2195	19	
21	Turning Radius (Outside)		mm	2210	21	
22	Load Distance (Centerline of front axle to front face of forks)		mm	485	22	
	Rear Overhang		mm	355		
23	Basic Right Angle Stacking Aisle Width (Add load length and clearance)		mm	2695	23	
	Intersecting Aisle Width		mm	2005		
24	Speeds *	Travel, Max. (FWD/RVS)	Full Load	km/h	14.0/14.0	24
			No Load	km/h	15.0/15.0	
		Lifting	Full Load	mm/sec	320	25
			No Load	mm/sec	550	
26	Lowering	Full Load	mm/sec	500	26	
		No Load	mm/sec	500		
27	Drawbar Pull *	Full Load/ No Load	3-Minute Ratings	N (kg)	13060/12630 (1330/1280)	27
			5-Minute Ratings	N (kg)	13060/12630 (1330/1280)	
			60-Minute Ratings	N (kg)	5300/5590 (540/570)	
29	Gradeability *	Full Load/ No Load	3-Minute Ratings	% (tanθ)	17/22	29
			5-Minute Ratings	% (tanθ)	17/22	
			30-Minute Ratings	% (tanθ)	11/19	
32	Total Weight	Without Battery	kg	3690	32	
33	Weight Distribution (With STD Battery)	Full Load	Front	kg	6880	33
			Rear	kg	830	
34		No Load	Front	kg	2090	34
			Rear	kg	2620	
35	Tires	Number	Front/Rear	2/2	35	
36		Size	Front	28X9-15-14PR (I)	36	
37			Rear	6.50-10-10PR (I)	37	
38	Wheelbase		mm	1650	38	
39	Tread	Front	mm	1010	39	
		Rear	mm	965		
	Backrest Height			1220		
	Overhead Guard Clearance			1035		
	Counterweight Height			1275		
	Drawbar Height			340		
	Step Height/Floor Height			515/785		
40	Underclearance	Mast (Full Load)	mm	115	40	
41		Center of Wheelbase (Full Load)	mm	140	41	
		Drive Axle (Full Load)	mm	155		
		Steer Axle (No Load)	mm	180		
		Counterweight (No Load)	mm	185		
		Minimum Under Clearance (Full Load)	mm	115(Mast)		
	Grade Clearance	Frame	% (tanθ)	36		
		Counterweight	% (tanθ)	95		
42	Brake	Service (Foot)		Hydraulic	42	
43		Parking			Hand	43
45	Battery	Voltage/Capacity (5-hour rating)	STD	V/AH	80/370	45
		High	V/AH	80/470		
46		Weight (STD Capacity Type)	kg	1020	46	
47	Electric Motors	Drive	kW	11.9	47	
48		Load Handling	kW	14.4	48	
		Energy Consumption According to VDI Cycle **	kWh/h	5.0	-	
54	Control Type	Drive		Transistor inverter	54	
		Load Handling		Transistor inverter		
57	Operating Pressure	For Attachments	Mpa (psi)	14.7 (2100)	57	
	Sound level at the driver's ear according to EN12053 Uncertainty 4dB(A)		dB (A)	69		
	Vibration in accordance with in EN13059		m/s ²	1.5		

NOTE: * Computed values.

** 60 VDI circles/h with Tested Load of 3000 kg.

DIMENSIONAL DRAWINGS

Unit: mm

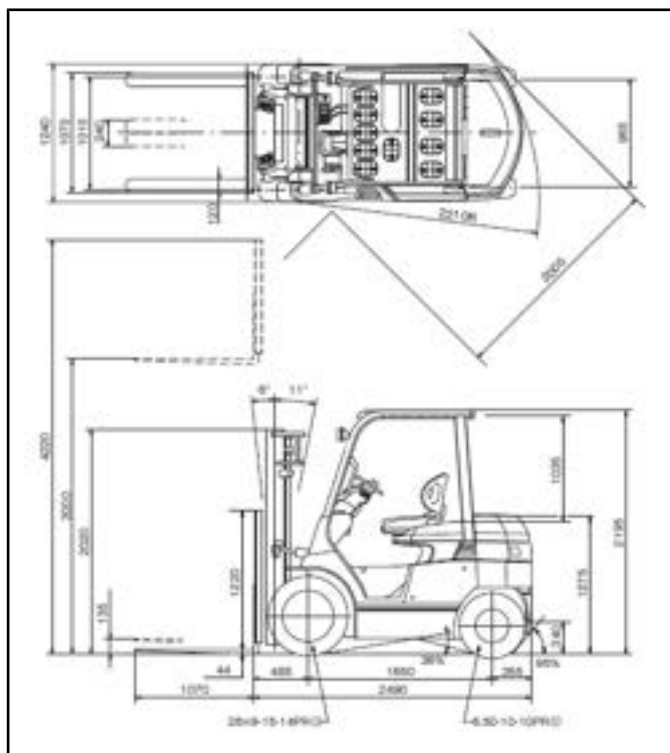

UNDERCLEARANCE

Mast (Full Load)	115
Center of Wheelbase (Full Load)	140
Drive Axle (Full Load)	155
Steer Axle (No Load)	180
Counterweight (No Load)	185
Minimum Under Clearance (No Load)	115(Mast)

RATED CAPACITIES

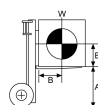

A: Max. Fork Height
B: Load Center
W: Capacity

V, FV Mast

Unit: kg (W)

A (mm)		3000	3300	3500	3700	4000	4500	5000
Single	500	3000	3000	3000	3000	3000	2850	2350
	600	2720	2720	2720	2720	2720	2580	2130
	700	2490	2490	2490	2490	2490	2360	1950
	800	2290	2290	2290	2290	2290	2180	1800
	900	2130	2130	2130	2130	2130	2020	1670
	1000	1980	1980	1980	1980	1980	1880	1550
	1100	1860	1860	1860	1860	1860	1770	1450
Dual	1200	1750	1750	1750	1750	1750	1660	1370
	1300	1650	1650	1650	1650	1650	1570	1290
	500	3000	3000	3000	3000	3000	3000	3000
	600	2720	2720	2720	2720	2720	2720	2720
	700	2490	2490	2490	2490	2490	2490	2490
	800	2290	2290	2290	2290	2290	2290	2290
	900	2130	2130	2130	2130	2130	2130	2130
1000	1980	1980	1980	1980	1980	1980	1980	
1100	1860	1860	1860	1860	1860	1860	1860	
1200	1750	1750	1750	1750	1750	1750	1750	
1300	1650	1650	1650	1650	1650	1650	1650	

FSV Mast

Unit: kg (W)

A (mm)		3700	4000	4300	4500	4700	5000	5500	6000
Single	500	3000	3000	3000	2800	2800	2400	1900	1450
	600	2720	2720	2720	2540	2540	2180	1720	1310
	700	2490	2490	2490	2330	2330	1990	1580	1200
	800	2300	2300	2300	2150	2150	1840	1450	1110
	900	2130	2130	2130	1990	1990	1710	1350	1030
	1000	1990	1990	1990	1860	1860	1590	1260	960
	1100	1870	1870	1870	1740	1740	1490	1180	900
Dual	1200	1760	1760	1760	1640	1640	1400	1110	850
	1300	1660	1660	1660	1550	1550	1320	1050	800
	500	3000	3000	3000	3000	3000	2900	2650	2050
	600	2720	2720	2720	2720	2720	2630	2400	1860
	700	2490	2490	2490	2490	2490	2410	2200	1700
	800	2300	2300	2300	2300	2300	2220	2030	1570
	900	2130	2130	2130	2130	2130	2060	1880	1460
1000	1990	1990	1990	1990	1990	1920	1760	1360	
1100	1870	1870	1870	1870	1870	1800	1650	1270	
1200	1760	1760	1760	1760	1760	1700	1550	1200	
1300	1660	1660	1660	1660	1660	1600	1460	1130	

MAST SPECIFICATIONS & RATED CAPACITIES

Mast Type	Maximum Fork Height	Overall Height			Free Lift		Tilt Range		Load Capacity at 500 mm LC	
		Lowered	Extended		Without Load Backrest	With Standard Load Backrest	FWD	BWD	PN	PSC
			Without Load Backrest	With Standard Load Backrest						
Wide Visible Mast (V)	2500	1770	3220	3570	135	135	6	11	3000	3000
	2700	1870	3420	3770	135	135	6	11	3000	3000
	3000	2020	3720	4070	135	135	6	11	3000	3000
	3300	2170	4020	4370	135	135	6	11	3000	3000
	3500	2270	4220	4570	135	135	6	11	3000	3000
	3700	2430	4420	4770	135	135	6	11	3000	3000
	4000	2620	4720	5070	135	135	6	11	3000	3000
	4500	2870	5220	5570	135	135	6	5	2850	3000
Wide Visible Full-Free Lift Two-Stage Mast (FV)	5000	3120	5720	6070	135	135	6	5	2350	3000
	3000	2020	3615	4070	1405	950	6	11	3000	3000
	3300	2170	3915	4370	1555	1100	6	11	3000	3000
	3500	2270	4115	4570	1655	1200	6	11	3000	3000
	3700	2430	4315	4770	1815	1360	6	11	3000	3000
Wide Visible Full-Free Lift Three-Stage Mast (FSV)	4000	2620	4615	5070	2005	1550	6	11	3000	3000
	3700	1920	4315	4770	1305	850	6	5	3000	3000
	4000	2020	4615	5070	1405	950	6	5	3000	3000
	4300	2170	4915	5370	1555	1100	6	5	3000	3000
	4500	2220	5115	5570	1605	1150	6	5	2800	3000
	4700	2270	5315	5770	1655	1200	6	5	2800	3000
	5000	2430	5615	6070	1815	1360	6	5	2400	2900
5500	2620	6115	6570	2005	1550	6	5	1900	2650	
6000	2870	6615	7070	2255	1800	6	5	1450	2050	

NOTE: Height of standard load backrest is 1070 mm.

3,500 kg

MAIN VEHICLE SPECIFICATIONS

1	Manufacturer			TOYOTA	1	
2	Model			8FBJ35	2	
3	Load Capacity		kg	3500	3	
4	Load Center		mm	500	4	
5	Power Type			Battery	5	
6	Operator Position			Rider Seated	6	
7	Tire Type		Front/Rear	Pneumatic	7	
8	Wheels (x = driven)		Front/Rear	2x/2	8	
9	Maximum Fork Height (MFH)		mm	3000	9	
10	Free Lift		mm	140	10	
13	Fork Size		L x W x T	1070/140/50	13	
	Fork Spread (Outside)		MAX./MIN.	1070/240		
14	Tilt Range		FWD/BWD	6/11	14	
15	Length to Fork Face		mm	2575	15	
16	Overall Width		mm	1240	16	
17	Mast Lowered Height		mm	2110	17	
18	Mast Extended Height		mm	4220	18	
19	Overhead Guard Height		mm	2195	19	
21	Turning Radius (Outside)		mm	2270	21	
22	Load Distance (Centerline of front axle to front face of forks)		mm	500	22	
	Rear Overhang		mm	425		
23	Basic Right Angle Stacking Aisle Width (Add load length and clearance)		mm	2770	23	
	Intersecting Aisle Width		mm	2045		
24	Speeds *	Travel, Max. (FWD/RVS)	Full Load	km/h	13.0/13.0	24
			No Load	km/h	15.0/15.0	
		Lowering	Full Load	mm/sec	270	25
			No Load	mm/sec	460	
26			Full Load	mm/sec	500	26
			No Load	mm/sec	450	
27	Drawbar Pull *	Full Load/ No Load	3-Minute Ratings	N (kg)	12900/12550 (1310/1280)	27
			5-Minute Ratings	N (kg)	12900/12550 (1310/1280)	
			60-Minute Ratings	N (kg)	5100/5490 (520/560)	
29	Gradeability *	Full Load/ No Load	3-Minute Ratings	% (tanθ)	14/20	29
			5-Minute Ratings	% (tanθ)	14/20	
			30-Minute Ratings	% (tanθ)	9/17	
32	Total Weight	Without Battery	kg	4290	32	
33	Weight Distribution (With STD Battery)	Full Load	Front	kg	7840	33
			Rear	kg	970	
34		No Load	Front	kg	2220	34
			Rear	kg	3090	
35	Tires	Number	Front/Rear	2/2	35	
36		Size	Front	28X9-15-14PR (I)	36	
37			Rear	6.50-10-14PR (I)	37	
38	Wheelbase		mm	1650	38	
39	Tread	Front	mm	1010	39	
		Rear	mm	965		
	Backrest Height			1220		
	Overhead Guard Clearance			1035		
	Counterweight Height			1275		
	Drawbar Height			340		
	Step Height/Floor Height			515/785		
40	Underclearance	Mast (Full Load)		mm	115	40
41		Center of Wheelbase (Full Load)		mm	140	41
		Drive Axle (Full Load)		mm	155	
		Steer Axle (No Load)		mm	180	
		Counterweight (No Load)		mm	185	
		Minimum Under Clearance (Full Load)		mm	115(Mast)	
	Grade Clearance	Frame	% (tanθ)	36		
		Counterweight	% (tanθ)	66		
42	Brake	Service (Foot)		Hydraulic	42	
43		Parking		Hand	43	
45	Battery	Voltage/Capacity (5-hour rating)	STD	V/AH	80/370	45
		High	V/AH	80/470		
46	Weight (STD Capacity Type)		kg	1020	46	
47	Electric Motors	Drive	kW	11.9	47	
48		Load Handling	kW	14.4	48	
		Energy Consumption According to VDI Cycle **	kWh/h	5.5		
54	Control Type	Drive		Transistor inverter	54	
		Load Handling		Transistor inverter		
57	Operating Pressure	For Attachments	Mpa (psi)	14.7(2100)	57	
	Sound level at the driver's ear according to EN12053 Uncertainty 4dB(A)		dB (A)	69		
	Vibration in accordance with in EN13059		m/s2	1.5		

NOTE: * Computed values.

** 60 VDI circles/h with Tested Load of 3500 kg.

DIMENSIONAL DRAWINGS

Unit: mm

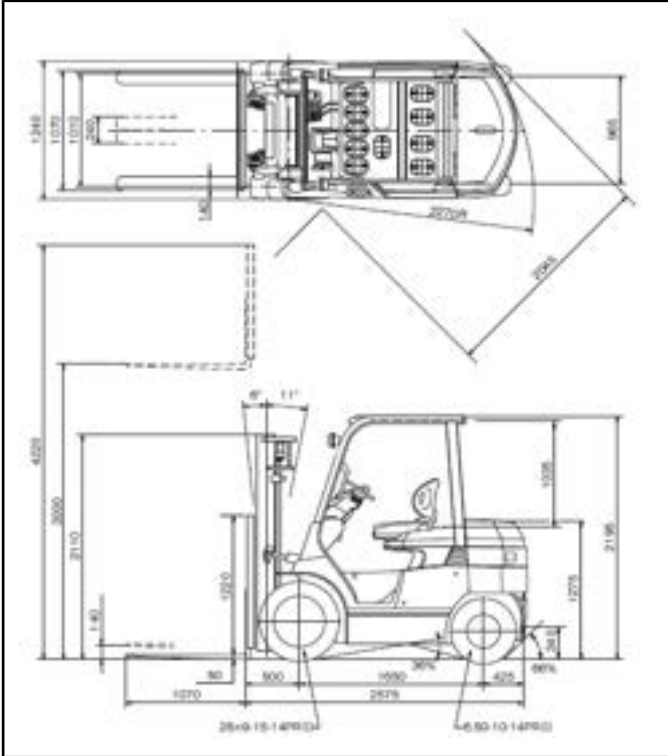

UNDERCLEARANCE

Mast (Full Load)	115
Center of Wheelbase (Full Load)	140
Drive Axle (Full Load)	155
Steer Axle (No Load)	180
Counterweight (No Load)	185
Minimum Under Clearance (No Load)	115(Mast)

RATED CAPACITIES

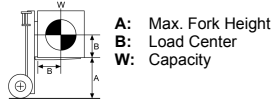

V, FV Mast

Unit: kg (W)

A (mm)	3000	3300	3500	3700	4000	4500	5000
Single	500	3500	3500	3500	3500	3500	2750
	600	3180	3180	3180	3180	3180	2490
	700	2910	2910	2910	2910	2910	2290
	800	2690	2690	2690	2690	2690	2110
	900	2490	2490	2490	2490	2490	1960
	1000	2330	2330	2330	2330	2330	1830
	1100	2180	2180	2180	2180	2180	1710
Dual	1200	2050	2050	2050	2050	2050	1610
	1300	1940	1940	1940	1940	1940	1520
	500	3500	3500	3500	3500	3500	3400
	600	3180	3180	3180	3180	3180	3090
	700	2910	2910	2910	2910	2910	2830
	800	2690	2690	2690	2690	2690	2610
	900	2490	2490	2490	2490	2490	2420
Dual	1000	2330	2330	2330	2330	2330	2260
	1100	2180	2180	2180	2180	2180	2120
	1200	2050	2050	2050	2050	2050	1990
	1300	1940	1940	1940	1940	1940	1880

FSV Mast

Unit: kg (W)

A (mm)	3700	4000	4300	4500	4700	5000	5500	6000
Single	500	3500	3500	3500	2900	2900	2500	1500
	600	3180	3180	3180	2630	2630	2270	1360
	700	2920	2920	2920	2420	2420	2080	1250
	800	2690	2690	2690	2230	2230	1920	1150
	900	2500	2500	2500	2070	2070	1790	1070
	1000	2340	2340	2340	1930	1930	1670	1000
	1100	2190	2190	2190	1810	1810	1560	940
Dual	1200	2060	2060	2060	1710	1710	1470	880
	1300	1950	1950	1950	1610	1610	1390	830
	500	3500	3500	3500	3400	3400	3300	2200
	600	3180	3180	3180	3090	3090	3000	2000
	700	2920	2920	2920	2830	2830	2750	1830
	800	2690	2690	2690	2620	2620	2540	1690
	900	2500	2500	2500	2430	2430	2360	1570
Dual	1000	2340	2340	2270	2270	2200	1930	1470
	1100	2190	2190	2130	2130	2060	1810	1370
	1200	2060	2060	2000	2000	1940	1710	1290
	1300	1950	1950	1950	1890	1890	1840	1220

MAST SPECIFICATIONS & RATED CAPACITIES

Mast Type	Maximum Fork Height	Overall Height			Free Lift		Tilt Range		Load Capacity at 500 mm LC	
		Lowered	Extended		Without Load Backrest	With Standard Load Backrest	FWD	BWD	PN	PSC
			Without Load Backrest	With Standard Load Backrest						
Wide Visible Mast (V)	2500	1890	3360	3570	140	140	6	11	3500	3500
	2700	1990	3560	3770	140	140	6	11	3500	3500
	3000	2110	3860	4070	140	140	6	11	3500	3500
	3300	2290	4160	4370	140	140	6	11	3500	3500
	3500	2390	4360	4570	140	140	6	11	3500	3500
	3700	2490	4560	4770	140	140	6	11	3500	3500
	4000	2740	4860	5070	140	140	6	11	3500	3500
Wide Visible Full-Free Lift Two-Stage Mast (FV)	4500	2990	5360	5570	140	140	6	5	3350	3500
	5000	3240	5860	6070	140	140	6	5	2750	3400
	3000	2110	3725	4070	1385	1040	6	11	3500	3500
	3300	2290	4025	4370	1565	1220	6	11	3500	3500
	3500	2390	4225	4570	1665	1320	6	11	3500	3500
Wide Visible Full-Free Lift Three-Stage Mast (FSV)	3700	2490	4425	4770	1765	1420	6	11	3500	3500
	4000	2740	4725	5070	2015	1670	6	11	3500	3500
	3700	2020	4425	4770	1295	950	6	5	3500	3500
	4000	2170	4725	5070	1445	1100	6	5	3500	3500
	4300	2225	5025	5370	1495	1155	6	5	3500	3500
	4500	2270	5225	5570	1545	1200	6	5	2900	3400
	4700	2430	5425	5770	1705	1360	6	5	2900	3400
5000	2620	5725	6070	1895	1550	6	5	2500	3300	
5500	2870	6225	6570	2145	1800	6	5	1950	2900	
6000	3120	6725	7070	2395	2050	6	5	1500	2200	

NOTE: Height of standard load backrest is 1070 mm.

The data in this publication was determined based on our standard testing condition. Operating performance may vary depending on the actual specification and condition of the vehicle as well as the condition of the operating area.

STANDARD EQUIPMENT

8FB10.14.15.18.20.25.30.J35, 8FBH10.14.15.18.20.25, 40-8FB15.20.25

- Drive AC motor
- Load handling (Power Steering) AC motor
- Wide Visible Mast (V) [MFH: 3000 mm]
- Load backrest (Angled Lower Stay, V and FSV masts)
- Operator Presence Sensing System (OPS)
- Easy-down system (V mast)
- Multi-function display (Battery capacity indicator, Power-select function indicator, OPS indicator, Overheat warning, Low temperature warning, Parking brake warning indicator, Power meter, Battery overdischarge warning, Battery remaining-charge warning, Parking brake on/off alarm, Return-to-neutral warning, Digital diagnosis, Maximum speed limitation setting, Auto power off time setting)
- Power select function
- Power keep function
- Hour meter
- Auto power-off function
- Headlights
- ORS seat
- Memory tilt steering column
- Dual action parking brake
- Full hydraulic power steering
- Electric horn
- Emergency power shut-down button
- Battery connector handle
- Floor mat
- Assist grip
- Storage area
- Document crimp
- Overhead guard
- Overhead guard cap

Availability and specifications are determined by market and are subject to change without notice.
Please consult your Toyota representative for details.

All rights reserved by Toyota Industries Corporation.



TOYOTA MATERIAL HANDLING INTERNATIONAL

S.S.8FB10-J35/E-1611/(S)/Printed in Japan/No.720760E0/800